



Science **made** smarter

Instructions for Use - US

PA5



D-0131335-B 2025/01

Table of contents

1	Introduction.....	1
1.1	About this manual	1
1.2	Intended purpose	1
1.3	Intended user	1
1.4	Indications for use	1
1.5	Target population	1
1.6	Contraindications	1
1.7	Delivered items with PA5:	1
1.8	Warnings	2
2	Unpacking and installation.....	3
2.1	Unpacking and inspection	3
2.2	Marking.....	4
2.3	General warnings and precautions	4
2.4	Malfunction	5
2.5	Disposal of the product	5
3	Getting started - setup and installation.....	6
3.1	Replacing batteries	9
3.1.1	Approximate battery lifetime	9
3.2	Description of various tests	10
3.3	Reflex audiometry by Neonates	10
3.4	Maturation of auditory response.....	11
4	Maintenance.....	13
4.1	How to clean Interacoustics products	13
4.2	Concerning repair.....	14
4.3	Warranty.....	14
5	Technical specifications	15
5.1	Calibration values.....	16
5.2	Standards for production and calibration.....	16
5.3	Pin assignment.....	18
5.4	Electromagnetic Compatibility (EMC)	19



1 Introduction

1.1 About this manual

This manual is valid for the PA5. The product is manufactured by:

Interacoustics A/S
Audiometer Allé 1
5500 Middelfart
Denmark
Tel.: +45 6371 3555
E-mail: info@interacoustics.com
Web: www.interacoustics.com

1.2 Intended purpose

The PA5 handheld pediatric screening audiometer is intended to generate a range of specific acoustic stimuli through the loudspeaker to assist the user in the early indication of hearing impairments amongst children. In addition to auditory stimuli, visual stimuli are also provided to facilitate the assessment of behavioral responses to the acoustic signals. The PA5 system aims to assist in the early detection of hearing impairments. The device should only be used in quiet surroundings.

1.3 Intended user

The PA5 audiometer is intended to be used by trained personnel only, such as audiologists, ENT surgeons, doctors, hearing healthcare professionals or personnel with a similar level of education. The device should not be used without the necessary knowledge and training to understand its use and how results should be interpreted.

1.4 Indications for use

There are no medical indications for this device.

1.5 Target population

The target patient population is for children up to 2 years old.

1.6 Contraindications

There are no known contraindications for the use of PA5.

1.7 Delivered items with PA5:

- PA5 Paediatric Free Field Audiometer
- 3 AA Batteries
- PA5 Handbag
- Getting started document

Optional parts:

- TDH39 Headphone

Year of production and standard to comply to

- Released to market in 1999
- IEC 60645-1:1992 and ANSI S3.6-1996

Check numbers on PA5 and manual:

The identification label on the rear plate holds the serial number. This should be checked with the manual number and written down for later service claims.



1.8 Warnings

Throughout this manual the following meaning of warnings, cautions and notices are used:



WARNING

The **WARNING** label identifies conditions or practices that may present danger to the patient and/or user.



CAUTION

CAUTION, used with the safety alert symbol, indicates a hazardous situation which, if not avoided, could result in damage of the equipment.

NOTICE

NOTICE is used to address practices not related to personal injury or damage of the equipment.



2 Unpacking and installation

2.1 Unpacking and inspection

Check box and contents for damage

When the instrument is received, please check the shipping box for rough handling and damage. If the box is damaged it should be kept until the contents of the shipment have been checked mechanically and electrically. If the instrument is faulty, please contact your local distributor. Keep the shipping material for the carrier's inspection and insurance claim.

Keep carton for future shipment

The PA5 comes in its own shipping carton, which is specially designed for the PA5. Please keep this carton. It will be needed if the instrument must be returned for service.

If service is required, please contact your local distributor.

Reporting Imperfections

Inspect before connection

Prior to connecting the product it should once more be inspected for damage. The cabinet and the accessories should be checked visually for scratches and missing parts.

Report immediately any faults

Any missing part or malfunction should be reported immediately to the supplier of the instrument together with the invoice, serial number, and a detailed report of the problem. In the back of this manual, you will find a "Return Report" where you can describe the problem.

Please use "Return Report"

Please realise that if the service engineer does not know what problem to look for, s/he may not find it, so using the Return Report will be of great help to us and is your best guarantee that the correction of the problem will be to your satisfaction.







Storage

If you need to store the PA5 for a period, please ensure it is stored under the conditions specified in the section for technical specifications.



2.2 Marking

The following marking can be found on the instrument:

Symbol	Explanation
	Type B applied parts. Patient applied parts that are not conductive and can be immediately released from the patient.
	WEEE (EU-directive) This symbol indicates that when the end-user wishes to discard this product, it must be sent to separate collection facilities for recovery and recycling.
	The CE-mark in combination with MD symbol indicates that Interacoustics A/S meets the requirements of the Medical Device Regulation (EU) 2017/745. Approval of the quality system is made by TÜV – identification no. 0123.
	Medical Device
	Year of manufacture
	Manufacturer

2.3 General warnings and precautions

NOTICE

Be sure to use only stimulation intensities, which will be acceptable for the patient.

NOTICE

A full audiologic evaluation should be administered if concerns about hearing sensitivity persist.

NOTICE

The transducers (headphones, bone conductor, etc.) supplied with the instrument are calibrated to this instrument - exchange of transducers require a recalibration.

WARNING

It is recommended that parts which are in direct contact with the patient (e.g., earphone cushions) are subjected to standard disinfecting procedure between patients. This includes physically cleaning and use of a recognised disinfectant. Individual manufacturer's instruction should be followed for use of this disinfecting agent to provide an appropriated level of cleanliness.



NOTICE

Always remove the batteries when the instrument is left unused for more than a month.

CAUTION

Although the instrument fulfils the relevant EMC requirements precautions should be taken to avoid unnecessary exposure to electromagnetic fields, e.g., from mobile phones etc.

If the device is used adjacent to other equipment it must be observed that no mutual disturbance appears.

NOTICE

Disposal of batteries must be made according to national regulations.

Although the instrument fulfils the relevant EMC requirements precautions should be taken to avoid unnecessary exposure to electromagnetic fields, e.g., from mobile phones etc. If the device is used adjacent to other equipment it must be observed that no mutual disturbance appears. Please also refer to EMC consideration in the appendix.

2.4 Malfunction



In the event of a product malfunction, it is important to protect patients, users, and other persons against harm. Therefore, if the product has caused, or potentially could cause such harm, it must be quarantined immediately.

Both harmful and harmless malfunctions, related to the product itself or to its use, must immediately be reported to the distributor where the product was acquired. Please remember to include as many details as possible e.g., the type of harm, serial number of the product, software version, connected accessories and any other relevant information.

NOTICE

In case of death or serious incident in relation to the use of the device, the incident must immediately be reported to Interacoustics and the local national competent authority.

2.5 Disposal of the product

Interacoustics is committed to ensuring that our products are safely disposed of when they are no longer usable. The cooperation of the user is important to ensure this. Interacoustics therefore expects that local sorting and waste regulations for disposal of electric and electronic equipment are followed, and that the device is not discarded together with unsorted waste.

In case the distributor of the product offers a take-back scheme, this should be used to ensure correct disposal of the product.



3 Getting started - setup and installation

The instructions included in this manual describe the general functions of the instrument.

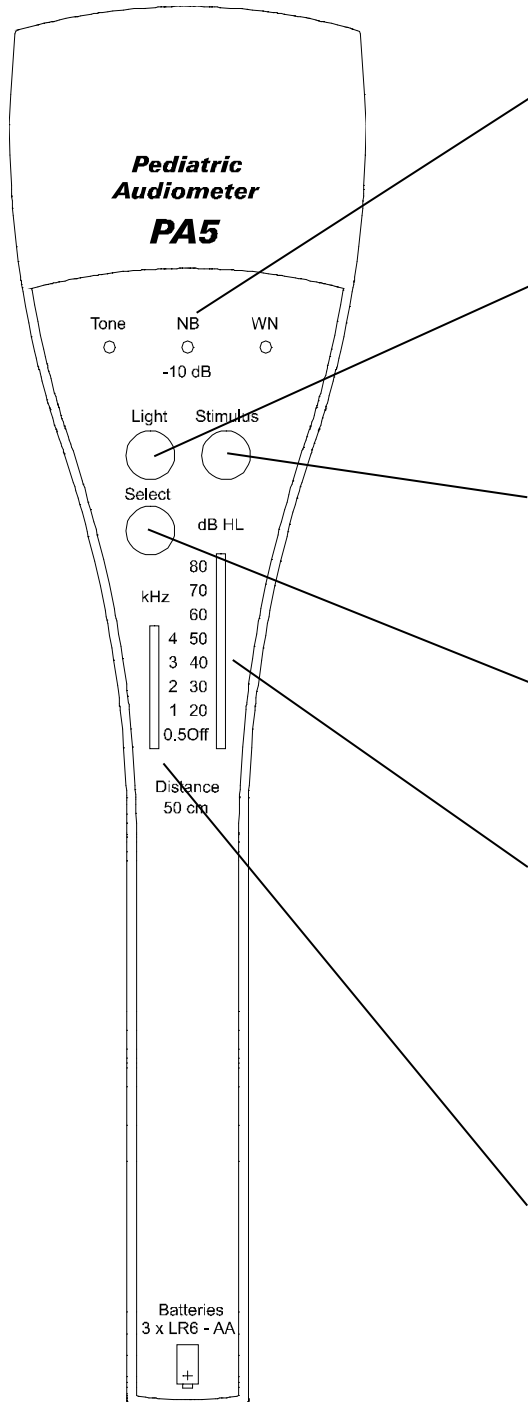

Description of Control Panel

Indication of stimulus mode:

Indication LEDs informing the user of the present stimulus mode: Tone, NB or WN.

Light:

Light button to control the three red LEDs, which are arranged in a triangle above the speaker to condition the orientation reflex.

Stimulus:

Stimulus button to present the selected stimulus Tone, NB or WN.

Select:

Select button to select between the three different stimuli Tone, NB or WN.

Intensity dB HL:

With the intensity control switch intensities between 20 and 80 dB, HL can be selected in steps of 10 dB when the distance between the ear and the loudspeaker of the PA5 is 50 cm or the PA5 is switched off by leaving the intensity control switch in the "Off" position. When the PA5 is not activated for two minutes it will switch off automatically.

Frequency kHz:

With the frequency control switch it is possible to select between the following frequencies: 0.5, 1, 2, 3, and 4 kHz.



Description of Stimulus Panel

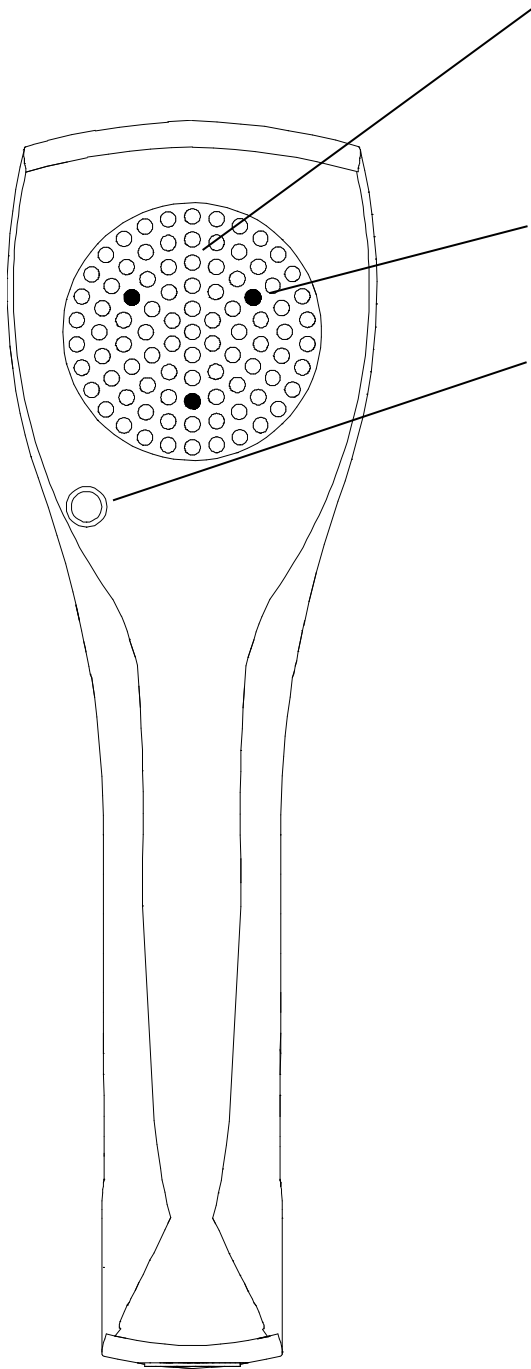

Loudspeaker:

The loudspeaker is to be found underneath the black grid. When used on a patient the grid should be positioned in 50 cm (20 inches) from the ear to obtain the intensities printed on the Control Panel.

LEDs:

Three LEDs arranged in a triangle for conditioning of the orientation reflex.

Headphone Connector:

Connector for single Headphone TDH39S (optional). When the headphone is connected PA5 will automatically go to Pure Tone stimulation and correct calibration for Pure Tone Audiometry will be applied.

Battery Description

Replacing Batteries:

To replace old batteries, unscrew the small black lid in the narrow end of PA5 and the batteries can be taken out.

Replace with three new AA batteries. When inserting the new batteries make sure that they are inserted correctly according to the small drawing in the bottom part of the control panel.

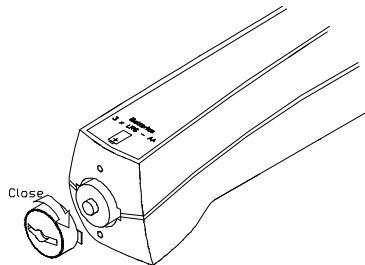

PA5 contains 3 batteries, size LR6, AA or Mignon.

Approximate Battery Lifetime:

The battery lifetime using Alkaline battery type:

With the instrument switched off: 12 months

With 80 dB tone switched on: 10 hours

With 80 dB tone and light switched on: 4 hours

Battery Level indication:

When the batteries need to be replaced the LED indication for the present used stimulus will gradually reduce in light intensity and finally switch off.

Note: Always remove the batteries when the instrument is left unused for a longer period.



3.1 Replacing batteries

To replace old batteries, unscrew the small black lid in the narrow end of PA5 and the batteries can be removed. Replace with three new AA batteries. When inserting the new batteries please make sure that they are inserted correctly according to the small drawing in the bottom part of the control panel.

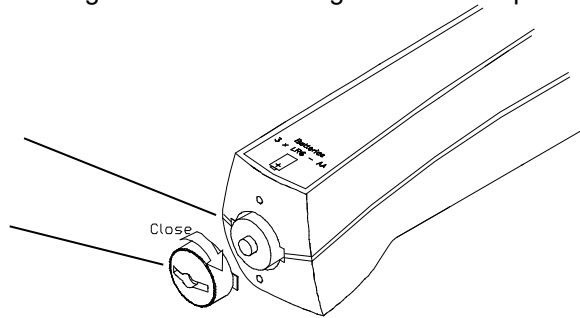

PA5 contains 3 batteries, size LR6, AA or Mignon. Alkaline or rechargeable (NiMH or NiCa).

3.1.1 Approximate battery lifetime

The battery lifetime using alkaline battery type:

With the instrument switched off:	12 months
With 80 dB tone switched on:	10 hours
With 80 dB tone and light switched on:	4 hours

Battery Level indication:

When the batteries need to be replaced the LED indication for the present used stimulus will gradually reduce in light intensity and finally switch off.

Note: Always remove the batteries when the instrument is left unused for more than a month



3.2 Description of various tests

As found by Professor Sanford E. Gerber complex signals like White Noise (WN) assure better responsiveness on neonates and up to the age of approximately seven months than e.g., pure tones and Narrow Band Noise. Therefore, PA5 has the possibility of stimulating with WN.

The APR Test:

The Auropalpebral Reflex is a startle reflex of the eyelid elicited by relatively strong sounds, approximately 80 - 100 dB SPL (PA5 is calibrated in dB HL).

The test can be performed on neonates from the day of birth, and it is not based on co-operation with the new-born child. Other responses than the APR can be arousal from sleep, crying or diminished activity.

The COR Test:

The Paediatric Audiometer PA5 can perform Conditioned Orientation Audiometry based on a technique described by Suzuki and Ogiba (1961). The phenomenon called "Orientation Reflex" is not a learned response, but a natural reflex movement elicited by sound or visual stimulation.

If the visual stimulation elicits a reflex which is conditioned by a tone, the child will look towards the visual stimulation, e.g., flashing light, as soon as the tone is heard. If the conditioning is effective the child will look in the direction of the sound source even before the visual stimulation is presented. The COR method requires cooperation from the child.

The VRA Test:

The Paediatric Audiometer PA5 can perform the Visual Reinforcement Audiometry (Liden and Kankunen, 1969), which is an extension and modification of COR, where the co-operation with the child is less important. Liden and Kankunen accept not only the sound localisation orientation reflex, but also four other reactions: reflex reactions (body and face), search reactions, orientation reactions and spontaneous reactions.

3.3 Reflex audiometry by Neonates

The reflex pattern elicited by sound can be divided into the following types of reflexes (Relke and Frey 1966). The sound intensity is 75 – 90dB.

Breathing Reflex

The breathing rhythm is changing when the sound is heard and should stabilise after 5-10 seconds.

Auropalpebral Reflex (APR)

The open eyelids will be closed fast and clear.

Moving Reflex

The neonatal child will move heavily after a quiet period.

Crying Reflex (Scream)

The face of the child will indicate discomfort and shortly after followed by weeping or a scream.

Astonishment Reflex

Crying and body movements stop momentarily as if the child is asking: "What is going on"?

Waking up Reflex

The breathing rate is accelerating; the child starts moving, wakes up and opens the eyes.



3.4 Maturation of auditory response



New-born to 2 months of age

Arousal from sleep. MRL¹ in quiet surroundings 50-70 dB.

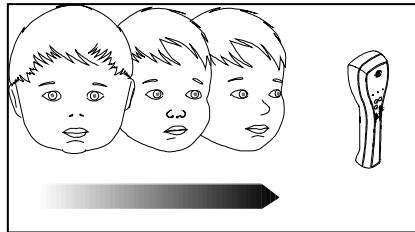

MRL in noisy surroundings: 90 d 3-4 months of age

Rudimentary head turn, horizontally.
MRL: 50-60 dB.

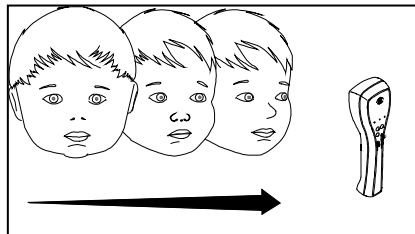

4-7 months of age

Sound localisation to the side only, not above or below eye level.
MRL: 40-50 dB.

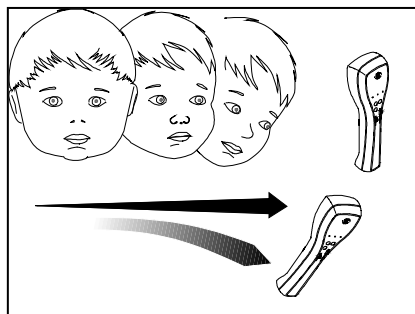

7-9 months of age

Sound localisation to the side and Indirect below. (Not above).
MRL: 30-40 dB.

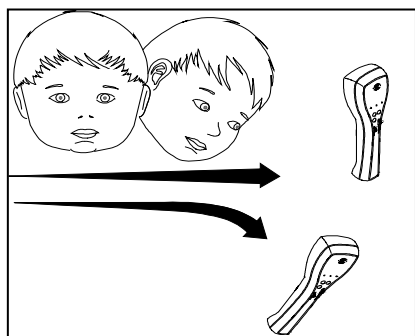

9-13 months of age

Sound localisation to the side and direct below.
MRL: 25-35 dB.

¹ Minimum response level, dB HL. The MRL levels are recorded in sound cabins. In noisy surroundings the levels will have to be correspondingly higher.

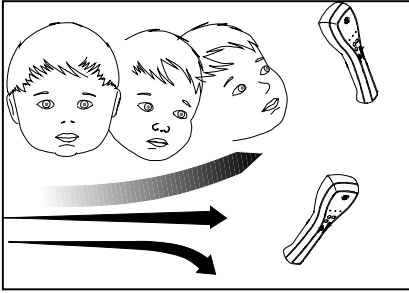

13-16 months of age

Sound localisation to the side, below and indirect above.
MRL: 25-35 dB.

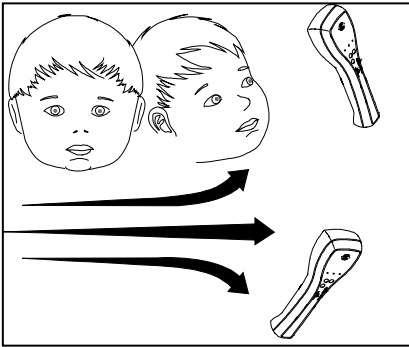

16-21 months of age

Direct sound localisation to the side, below, indirect above.
MRL: 25-35 dB.

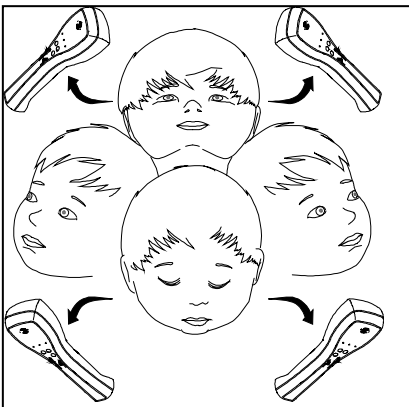

21-24 months of age

Locates directly sound at any angle.
MRL: 25-30 dB.



4 Maintenance

The performance and safety of the instrument will be kept if the following recommendations for care and maintenance are observed:

- It is recommended to let the instrument go through at least one annual overhaul, to ensure that the acoustical, electrical, and mechanical properties are correct. This should be made by an authorised workshop to guaranty proper service and repair.
- Do not site the instrument next to a heat source of any kind and allow sufficient space around the instrument to ensure proper ventilation.
- To ensure that the reliability of the instrument is kept, it is recommended that the operator at short intervals, for instance once a day, perform a test on a person with known data. This person could be the operator him/herself.
- If the surface of the instrument or parts of it are contaminated, it can be cleaned using a soft cloth moistened with a mild solution of water and dish washing cleaner or similar. The use of organic solvents and aromatic oils must be avoided. Always be careful that no fluid is entering the inside of the instrument or the accessories.
- After each examination of a patient, it should be ensured that there is no contamination on the parts in connection with the patient. General precautions must be observed to avoid that disease from one patient is conducted to others. If ear cushions or ear tips are contaminated, it is strongly recommended to remove them from the transducer before they are cleaned. By frequent cleaning water should be used, but by severe contamination it may be necessary to use a disinfectant. The use of organic solvents and aromatic oils must be avoided.
- Great care should be exercised by the handling of earphones and other transducers, as mechanical shock may cause change of calibration.

4.1 How to clean Interacoustics products

If the surface of the instrument or parts of it are contaminated, it can be cleaned using a soft cloth moistened with a mild solution of water and dish washing cleaner or similar. The use of organic solvents and aromatic oils must be avoided. Always disconnect the USB cable during the cleaning process and be careful that no fluid is entering the inside of the instrument or the accessories.



CAUTION

- Before cleaning always switch off and disconnect from power
- Use a soft cloth lightly dampened with cleaning solution to clean all exposed surfaces
- Do not allow liquid to get in contact with the metal parts inside the earphones / headphones
- Do not autoclave, sterilize, or immerse the instrument or accessory in any fluid
- Do not use hard or pointed objects to clean any part of the instrument or accessory
- Do not let parts that have been in contact with fluids dry before cleaning
- Rubber ear-tips or foam ear-tips are single use components

Recommended cleaning and disinfection solutions:

- Warm water with mild, nonabrasive cleaning solution (soap)

Procedure:

- Clean the instrument by wiping outer case with a lint free cloth lightly dampened in cleaning solution
- Clean cushions and patient hand switch and other parts with a lint free cloth lightly dampened in cleaning solution
- Make sure not to get moisture in the speaker portion of the earphones and similar parts

WARNING

It is recommended that parts which are in direct contact with the patient (e.g., earphone cushions) are subjected to standard disinfecting procedure between patients. This includes physically cleaning and use of



a recognised disinfectant. Individual manufacturer's instruction should be followed for use of this disinfecting agent to provide an appropriated level of cleanliness.

4.2 Concerning repair

Interacoustics is only considered to be responsible for the validity of the CE marking, effects on safety, reliability, and performance of the equipment if:

1. assembly operations, extensions, readjustments, modifications, or repairs are carried out by authorised persons,
2. a 1-year service interval is maintained
3. the electrical installation of the relevant room complies with the appropriate requirements, and
4. the equipment is used by authorised personnel in accordance with the documentation supplied by Interacoustics.

The customer shall reach out to the local distributor to determine the service/repair possibilities including onsite service/repair. It is important that the customer (through local distributor) fills out the **RETURN REPORT** every time when the component/product is sent for service/repair to Interacoustics.

4.3 Warranty

Interacoustics warrants that:

- The PA5 is free from defects in material and workmanship under normal use and service for a period of 12 months from the date of delivery by Interacoustics to the first purchaser
- Accessories are free from defects in material and workmanship under normal use and service for a period of ninety (90) days from the date of delivery by Interacoustics to the first purchaser

If any product requires service during the applicable warranty period, the purchaser should communicate directly with the local Interacoustics service centre to determine the appropriate repair facility. Repair or replacement will be carried out at Interacoustics' expense, subject to the terms of this warranty. The product requiring service should be returned promptly, properly packed, and postage prepaid. Loss or damage in return shipment to Interacoustics shall be at purchaser's risk.

In no event shall Interacoustics be liable for any incidental, indirect or consequential damages in connection with the purchase or use of any Interacoustics product.

This shall apply solely to the original purchaser. This warranty shall not apply to any subsequent owner or holder of the product. Furthermore, this warranty shall not apply to, and Interacoustics shall not be responsible for, any loss arising in connection with the purchase or use of any Interacoustics product that has been:

- repaired by anyone other than an authorized Interacoustics service representative;
- altered in any way so as, in Interacoustics judgement, to affect its stability or reliability;
- subject to misuse or negligence or accident, or which has had the serial or lot number altered, effaced, or removed; or
- improperly maintained or used in any manner other than in accordance with the instructions furnished by Interacoustics.

This warranty is in lieu of all other warranties, express or implied, and of all other obligations or liabilities of Interacoustics, and Interacoustics does not give or grant, directly or indirectly, the authority to any representative or other person to assume on behalf of Interacoustics any other liability in connection with the sale of Interacoustics products.

INTERACOUSTICS DISCLAIMS ALL OTHER WARRANTIES, EXPRESSED OR IMPLIED, INCLUDING ANY WARRANTY OF MERCHANTABILITY OR FOR FUNCTION OF FITNESS FOR A PARTICULAR PURPOSE OR APPLICATION.



5 Technical specifications

Medical CE-mark	The CE-mark in combination with MD symbol indicates that Interacoustics A/S meets the requirements of the Medical Device Regulation (EU) 2017/745. Approval of the quality system is made by TÜV – identification no. 0123.	
Safety Standards	IEC 60601-1:2005+AMD1:2012+AMD2:2020	
Audiometer standard	Type 5 Audiometer from IEC 60645-1:1992, ANSI S3.6-1996*	
EMC standard	IEC 60601-1-2:2014+AMD1:2020	
Free Field	ISO 389-7 2005, ANSI S3.6-2010	
TDH-39 single	ISO 389-1 1998 , ANSI S3.6-2010	
Power	Batteries	3 x 1.5 AA or 3 x 1.2V NiMH
	Volt:	3,4 - 5,0 V
Frequencies	500, 1000, 2000, 3000, 4000 Hz	
Sound levels	20 - 80 dB	
Stimuli	Warble Tone, NB, WN, Pure tone	
Intensities	Distance 50 cm	20 - 80 dB HL in 10 dB steps,
Warble Tone	5 Hz sine , 5% modulation	
Narrow band noise	5/12 Octave filter with the same centre frequency resolution as pure Tone.	
White Noise	80-20000Hz measured with constant bandwidth	
Sound Source	Built in loudspeaker or headphone TDH39	
Output specifications	Up to 1.5 Vrms by 10 Ω load	
Light Stimulation	3 LEDs arranged in a triangle; flash speed 5 Hz	
Tone and light stimulation	Silent touch switches with automatic battery switch	
Operation environment:	Temperature:	15-35 °C
	Relative humidity:	30-90%
	Ambient pressure:	98kPa – 104kPa
	Warm-up time:	None
Transport & storage:	Storage temperature:	0°C-50°C
	Transport temperature:	-20-50 °C
	Rel. humidity:	10-95%
Dimensions	L x W x H:	approx. 25 x 7,5 x 5 cm
	Weight:	approx. 0,4 kg

*Partially complies to IEC- IEC 60645-1:2017



5.1 Calibration values

Values used by calibration of the output levels for the applied transducers are generally found in international, national and/or in some cases internal product standards.

It is the responsibility of the person who makes the calibration, that the correct set of values is used here. The calibration charts for the test setup in question is used to ensure that the correct correction values are considered.

By the initial factory calibration, it is required that the standardized output levels are reached as close as possible, and they should in general be within a reading of ± 1 dB for all type of signals.

By follow-up control of calibration, the allowed deviation of the output levels for the common signal types according to IEC 60645 and ANSI S3.6-1996 are:

	IEC 60645	ANSI S3.6-1996
Air conduction:	± 3 dB at 125 Hz to 4000 Hz	± 3 dB at 125 Hz to 5000 Hz

5.2 Standards for production and calibration

Standards used:

For Sound Pressure Level of the loudspeaker: ISO 389-7

For Sound Pressure Level of the headphone: ISO 389-1

Values for Loudspeaker:

Frequency (Hz)	ISO 389-7 Tone (dB re. 20 μ Pa)	ISO 389-7 NB (dB re. 20 μ Pa)	White Noise in SPL
500	4,0	3,5	0 dB
1000	2,0	0,5	
2000	-1,5	-1,5	
3000	-6,0	-4,0	
4000	-6,5	-5,0	

Maximaler Stim Freq.	[dBHL] for dis. 50 cm Speaker			[dBHL] TDH39
	Tone	NB	WN	Tone
500	80	70		80
1000	80	70		80
2000	80	70	80	80
3000	80	70		80
4000	80	70		80



Pure Tone RETSPL	
Transducer	TDH-39
Impedance	10 Ω
Coupler	6ccm
	RETSPL
Frequency (Hz)	ISO 389 (dB re. 20 μPa)
Tone 500 Hz	11.5
Tone 1000 Hz	7
Tone 2000 Hz	9
Tone 3000 Hz	10
Tone 4000 Hz	9.5

TDH39 6ccm uses IEC60318-3 or NBS 9A coupler and RETSPL comes from ANSI S3.6 2018 and ISO 389-1 2017. Force 4.5N ±0.5N

SOUND ATTENUATION VALUES FOR EARPHONES

FREQUENCY	ATTENUATION
	TDH39 with MX41/AR or PN 51 Cushion
[Hz]	[dB]*
125	3
160	4
200	5
250	5
315	5
400	6
500	7
630	9
750	-
800	11
1000	15
1250	18
1500	-
1600	21
2000	26
2500	28
3000	-
3150	31
4000	32
5000	29
6000	-
6300	26
8000	24

*ISO 8253-1 2010

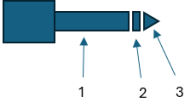

5.3 Pin assignment

Socket	Connector	Pin 1	Pin 2	Pin 3
Phone	 3.5 mm Mono	Ground	Signal	N/A



5.4 Electromagnetic Compatibility (EMC)

This equipment is suitable in hospital and clinical environments except for near-active HF surgical equipment and RF-shielded rooms of systems for magnetic resonance imaging, where the intensity of electromagnetic disturbance is high.

NOTICE: ESSENTIAL PERFORMANCE for this equipment is defined by the manufacturer as:
This equipment does not have an ESSENTIAL PERFORMANCE Absence or loss of ESSENTIAL PERFORMANCE cannot lead to any unacceptable immediate risk.
Final diagnosis shall always be based on clinical knowledge.

Use of this equipment adjacent to other equipment should be avoided because it could result in improper operation. If such use is necessary, this equipment and the other equipment should be observed to verify that they are operating normally.

Use of accessories and cables other than those specified or provided by the manufacturer of this equipment could result in increased electromagnetic emissions or decreased electromagnetic immunity of this equipment and result in improper operation. The list of accessories and cables can be found in this section.

Portable RF communications equipment (including peripherals such as antenna cables and external antennas) should be used no closer than 30 cm (12 inches) to any part of this equipment, including cables specified by the manufacturer. Otherwise, degradation of the performance of this equipment could result in improper operation.

This equipment complies with IEC60601-1-2:2014+AMD1:2020, emission class B group 1.

NOTICE: There are no deviations from the collateral standard and allowances uses.

NOTICE: All necessary instructions for maintenance comply with EMC and can be found in the general maintenance section in this instruction. No further steps required.

To ensure compliance with the EMC requirements as specified in IEC 60601-1-2, it is essential to use only the following accessories as applicable:

Item	Manufacturer	Model
Transducer	Radioear	TDH-39

Anyone connecting additional equipment is responsible for making sure the system complies with the IEC 60601-1-2 standard.

Conformance to the EMC requirements as specified in IEC 60601-1-2 is ensured if the cable types and cable lengths are as specified below:

Description	Length (meter)	Screened (Yes/No)
Audiometric headset	2.0	Yes

The use of the accessories, transducers, and cables with medical equipment/system other than this equipment may result in increased emissions or decreased immunity of the medical equipment/system.



Guidance and manufacturer's declaration - electromagnetic emissions		
The <i>Instrument</i> (PA5) is intended for use in the electromagnetic environment specified below. The customer or the user of the <i>Instrument</i> should assure that it is used in such an environment.		
Emissions Test	Compliance	Electromagnetic environment - guidance
RF emissions CISPR 11	Group 1	The <i>Instrument</i> uses RF energy only for its internal function. Therefore, its RF emissions are very low and are not likely to cause any interference in nearby electronic equipment. The <i>Instrument</i> is suitable for use in all commercial, industrial, business, and residential environments.
RF emissions CISPR 11	Class B	
Harmonic emissions IEC 61000-3-2	Not Applicable	
Voltage fluctuations / flicker emissions IEC 61000-3-3	Not applicable	

Recommended separation distances between portable and mobile RF communications equipment and the <i>Instrument</i> .			
The <i>Instrument</i> (PA5) is intended for use in an electromagnetic environment in which radiated RF disturbances are controlled. The customer or the user of the <i>Instrument</i> can help prevent electromagnetic interferences by maintaining a minimum distance between portable and mobile RF communications equipment (transmitters) and the <i>Instrument</i> as recommended below, according to the maximum output power of the communications equipment.			
Rated Maximum output power of transmitter [W]	Separation distance according to frequency of transmitter [m]		
	150 kHz to 80 MHz $d = 1.17\sqrt{P}$	80 MHz to 800 MHz $d = 1.17\sqrt{P}$	800 MHz to 2.7 GHz $d = 2.23\sqrt{P}$
0.01	0.12	0.12	0.23
0.1	0.37	0.37	0.74
1	1.17	1.17	2.33
10	3.70	3.70	7.37
100	11.70	11.70	23.30
For transmitters rated at a maximum output power not listed above, the recommended separation distance d in meters (m) can be estimated using the equation applicable to the frequency of the transmitter, where P is the maximum output power rating of the transmitter in watts (W) according to the transmitter manufacturer.			
Note 1 At 80 MHz and 800 MHz, the higher frequency range applies.			
Note 2 These guidelines may not apply to all situations. Electromagnetic propagation is affected by absorption and reflection from structures, objects and people.			



Guidance and Manufacturer's Declaration - Electromagnetic Immunity

The <i>Instrument</i> (PA5) is intended for use in the electromagnetic environment specified below. The customer or the user of the <i>Instrument</i> should assure that it is used in such an environment.			
Immunity Test	IEC 60601 Test level	Compliance	Electromagnetic environment - guidance
Electrostatic Discharge (ESD) IEC 61000-4-2	+8 kV contact +15 kV air	+8 kV contact +15 kV air	Floors should be wood, concrete or ceramic tile. If floors are covered with synthetic material, the relative humidity should be greater than 30%.
Immunity to proximity fields from RF wireless communications equipment IEC 61000-4-3	Spot freq. 385-5.785 MHz Levels and modulation defined in table 9	As defined in table 9	RF wireless communications equipment should not be used close to any parts of the <i>Instrument</i> .
Electrical fast transient/burst IEC61000-4-4	+2 kV for power supply lines +1 kV for input/output lines	Not applicable +1 kV for input/output lines	Mains power quality should be that of a typical commercial or residential environment.
Surge IEC 61000-4-5	+1 kV Line to line +2 kV Line to earth	Not applicable	Mains power quality should be that of a typical commercial or residential environment.
Voltage dips, short interruptions and voltage variations on power supply lines IEC 61000-4-11	0% <i>UT</i> (100% dip in <i>UT</i>) for 0.5 cycle, @ 0, 45, 90, 135, 180, 225, 270 and 315° 0% <i>UT</i> (100% dip in <i>UT</i>) for 1 cycle 40% <i>UT</i> (60% dip in <i>UT</i>) for 5 cycles 70% <i>UT</i> (30% dip in <i>UT</i>) for 25 cycles 0% <i>UT</i> (100% dip in <i>UT</i>) for 250 cycles	Not applicable	Mains power quality should be that of a typical commercial or residential environment. If the user of the <i>Instrument</i> requires continued operation during power mains interruptions, it is recommended that the <i>Instrument</i> be powered from an uninterruptible power supply or its battery.
Power frequency (50/60 Hz) IEC 61000-4-8	30 A/m	30 A/m	Power frequency magnetic fields should be at levels characteristic of a typical location in a typical commercial or residential environment.
Radiated fields in close proximity — Immunity test IEC 61000-4-39	9 kHz to 13.56 MHz. Frequency, level and modulation defined in AMD 1: 2020, table 11	As defined in table 11 of AMD 1: 2020	If the <i>Instrument</i> contains magnetically sensitive components or circuits, the proximity magnetic fields should be no higher than the test levels specified in Table 11

Note: *UT* is the A.C. mains voltage prior to application of the test level.



Guidance and manufacturer's declaration — electromagnetic immunity

The **Instrument** (PA5) is intended for use in the electromagnetic environment specified below. The customer or the user of the **Instrument** should assure that it is used in such an environment.

Immunity test	IEC / EN 60601 test level	Compliance level	Electromagnetic environment – guidance
Conducted RF IEC / EN 61000-4-6	3 Vrms 150kHz to 80 MHz 6 Vrms In ISM bands (and amateur radio bands for Home Healthcare environment.)	3 Vrms 6 Vrms	Portable and mobile RF communications equipment should be used no closer to any parts of the Instrument , including cables, than the recommended separation distance calculated from the equation applicable to the frequency of the transmitter. Recommended separation distance: $d = \frac{3,5}{V_{rms}} \sqrt{P}$
Radiated RF IEC / EN 61000-4-3	3 V/m 80 MHz to 2,7 GHz 10 V/m 80 MHz to 2,7 GHz Only for Home Healthcare environment	3 V/m 10 V/m (If Home Healthcare)	

$$d = \frac{3,5}{V/m} \sqrt{P} \quad 80 \text{ MHz to } 800 \text{ MHz}$$

$$d = \frac{7}{V/m} \sqrt{P} \quad 800 \text{ MHz to } 2,7 \text{ GHz}$$

Where *P* is the maximum output power rating of the transmitter in watts (W) according to the transmitter manufacturer and *d* is the recommended separation distance in meters (m).

Field strengths from fixed RF transmitters, as determined by an electromagnetic site survey,^a should be less than the compliance level in each frequency range.^b

Interference may occur in the vicinity of equipment marked with the following symbol:
⚠

NOTE1 At 80 MHz and 800 MHz, the higher frequency range applies

NOTE 2 These guidelines may not apply in all situations. Electromagnetic propagation is affected by absorption and reflection from structures, objects and people.

^a) Field strengths from fixed transmitters, such as base stations for radio (cellular/cordless) telephones and land mobile radios, amateur radio, AM and FM radio broadcast and TV broadcast cannot be predicted theoretically with accuracy. To assess the electromagnetic environment due to fixed RF transmitters, an electromagnetic site survey should be considered. If the measured field strength in the location in which the **Instrument** is used exceeds the applicable RF compliance level above, the **Instrument** should be observed to verify normal operation, If abnormal performance is observed, additional measures may be necessary, such as reorienting or relocating the **Instrument**.

^b) Over the frequency range 150 kHz to 80 MHz, field strengths should be less than 3 V/m.

Return Report – Form 001



Opr. dato: 2014-03-07 af: EC Rev. dato: af: MSt Rev. nr.: 4

Company: _____

Address: _____

Phone: _____

Fax or e-mail: _____

Address

10393 West 70th Street
Prairie
MN 55344
USA

Phone

(+1) 800 947 6334

Fax

(+1) 952 903 4200

E-mail

rmd@interacoustics-us.com

Contact person: _____ Date: _____

Following item is reported to be:

- returned to INTERACOUSTICS for: repair, exchange, other: _____
- defective as described below with request of assistance
- repaired locally as described below
- showing general problems as described below

Item: _____ **Type:** _____ **Quantity:** _____
Serial No.: _____ Supplied by: _____
Included parts: _____

Important! - Accessories used together with the item must be included if returned (e.g. external power supply, headsets, transducers and couplers).

Description of problem or the performed local repair:

Returned according to agreement with: Interacoustics, Other : _____

Date : _____ Person : _____

Please provide e-mail address or fax No. to whom Interacoustics may confirm reception of the returned goods:

The above mentioned item is reported to be dangerous to patient or user ¹

In order to ensure instant and effective treatment of returned goods, it is important that this form is filled in and placed together with the item.
Please note that the goods must be carefully packed, preferably in original packing, in order to avoid damage during transport. (Packing material may be ordered from Interacoustics)

¹ EC Medical Device Directive rules require immediate report to be sent, if the device by malfunction deterioration of performance or characteristics and/or by inadequacy in labelling or instructions for use, has caused or could have caused death or serious deterioration of health to patient or user. Page 1 of 1