



Science **made** smarter

Instructions for Use – US

AD226



Table of Contents

1	INTRODUCTION	1
1.1	About this Manual	1
1.2	Intended Use.....	1
1.3	Product Description.....	2
1.4	Warnings.....	2
2	UNPACKING AND INSTALLATION.....	3
2.1	Unpacking and Inspection.....	3
2.2	Marking	4
2.3	General Warnings and Precautions.....	4
2.4	Malfunction.....	6
3	GETTING STARTED - SETUP AND INSTALLATION	7
3.1	Back Panel Connections – Standard Accessories.....	7
3.2	PC-Interface.....	8
3.3	About Diagnostic Suite.....	8
3.4	Operating instructions	9
3.5	Tone test	12
3.6	Stenger Test.....	13
3.7	ABLB Test.....	13
3.8	Hughson-Westlake Test.....	14
3.8.1	Hughson-Westlake Setup	14
3.9	Sessions and clients	16
3.9.1	Save Session.....	16
3.9.2	View client.....	16
4	CARE AND MAINTENANCE	17
4.1	General Maintenance Procedures	17
4.2	How to clean Interacoustics Products.....	18
4.3	Concerning Repair	18
4.4	Warranty.....	19
5	GENERAL TECHNICAL SPECIFICATIONS.....	20
5.1	Reference Equivalent Threshold Values for transducers	21
5.2	Pin Assignments	21
5.3	Electromagnetic Compatibility (EMC)	21



1 Introduction

1.1 About this Manual

This manual is valid for the AD226. These products are manufactured by:

Interacoustics A/S

Audiometer Allé 1

5500 Middelfart

Denmark

Tel.: +45 6371 3555

Fax: +45 6371 3522

E-mail: info@interacoustics.com

Web: www.interacoustics.com

1.2 Intended Use

The AD226 diagnostic audiometer is designed to be a device for diagnosing hearing loss. Output and specificity of this type of device are based on the test characteristics defined by the user and may vary depending on environmental and operating conditions. The diagnosing of hearing loss using this kind of diagnostic audiometer depends on the interaction with the patient. However, for patients not responding well possibilities of various tests allow the tester of having at least some evaluative result. Thus, a “normal hearing” result should not allow for ignoring other contra indications in this case. A full audiologic evaluation should be administered if concerns about hearing sensitivity persist.

The AD226 audiometer is intended to be used by an audiologist, hearing healthcare professional, or trained technician in an extremely quiet environment according to the ISO standard 8253-1. This instrument is intended for all patient groups regarding sex, age, and health. Careful handling of instrument whenever in contact with patient should be of high priority. Calm and stable positioning while testing is preferred for optimal accuracy.



1.3 Product Description



The AD226 is a 1½ channel portable audiometer offering air and bone conduction test capabilities with masking. It offers a range of special test features such as SISI, HW, Stenger and Langenbeck.

As standard AD226 is delivered with the following:

Included parts	DD45 Audiometric headset B71 Bone conductor APS3 Patient response button Power supply Operation manual CD Multilingual CE instructions for use
Optional parts	Diagnostic Suite software OtoAccess® database 21925 Amplivox audiocups, noise reducing headset Carrying case (Standard or Trolley Style) EARTone3A Audiometric insert phones TDH39 Audiometric headset IP30 Insert phones DD45 Audiometric headset P3100 (Pediatric headband) DD450 Audiometric headset DD65v2 Audiometric Headset

1.4 Warnings

Throughout this manual the following meaning of warnings, cautions and notices are used:

	WARNING indicates a hazardous situation which, if not avoided, could result in death or serious injury.
	CAUTION , used with the safety alert symbol, indicates a hazardous situation which, if not avoided, could result in damage of the equipment.
NOTICE	NOTICE is used to address practices not related to personal injury.



2 Unpacking and installation

2.1 Unpacking and Inspection

Check box and contents for damage

When the instrument is received please check the shipping box for rough handling and damage. If the box is damaged it should be kept until the contents of the shipment have been checked mechanically and electrically. If the instrument is faulty please contact your local distributor. Keep the shipping material for the carrier's inspection and insurance claim.

Keep carton for future shipment

The AD226 comes in its own shipping carton, which is specially designed for the AD226. Please keep this carton. It will be needed if the instrument has to be returned for service. If service is required please contact your local distributor.

Reporting Imperfections

Inspect before connection

Prior to connecting the product it should once more be inspected for damage. All of the cabinet and the accessories should be checked visually for scratches and missing parts.

Report immediately any faults

Any missing part or malfunction should be reported immediately to the supplier of the instrument together with the invoice, serial number, and a detailed report of the problem. In the back of this manual you will find a "Return Report" where you can describe the problem.

Please use "Return Report"

Please realise that if the service engineer does not know what problem to look for he may not find it, so using the Return Report will be of great help to us and is your best guarantee that the correction of the problem will be to your satisfaction.







Storage

If you need to store the AD226 for a period, please ensure it is stored under the conditions specified in the section for technical specifications.



2.2 Marking

The following marking can be found on the instrument:

Symbol	Explanation
	Type B applied parts. Patient applied parts that are not conductive and can be immediately released from the patient.
	Refer to instruction manual
	WEEE (EU-directive) This symbol indicates that when the end-user wishes to discard this product, it must be sent to separate collection facilities for recovery and recycling. Failing to do so may endanger the environment.
	The CE-mark indicates that Interacoustics A/S meets the requirements of Annex II of the Medical Device Directive 93/42/EEC. TÜV Product Service, Identification No. 0123, has approved the quality system.
	Medical device
	Year of manufacture
	Do not re-use Parts like ear-tips and similar are for single use only

NOTICE Type plate is located beneath the instrument

2.3 General warnings and precautions



External equipment intended for connection to signal input, signal output or other connectors shall comply with relevant IEC standard (e.g. IEC 60950 for IT equipment). In these situations, an optical isolator is recommended to fulfill the requirements. Equipment not complying with IEC 60601-1 shall be kept outside the patient environment, as defined in the standard (usually 1.5 meter). If in doubt, contact qualified medical technician or your local representative.

This instrument does not incorporate any separation devices at connections for PC's, printers, active speakers etc. (Medical Electrical System)



When the instrument is connected to a PC and other items of equipment of a medical electrical system assure that the total leakage current cannot exceed the safety limits and that separations have the dielectric strength, creepage clearances and air clearances required fulfilling the requirements of IEC/ES 60601-1. When the instrument is connected to a PC and other similar items be aware of not touching the PC and patient simultaneously

This instrument contains a coin-type lithium battery. The cell can only be changed by service personnel. Batteries may explode or cause burns, if disassembled, crushed or exposed to fire or high temperatures. Do not short-circuit.

No modification of this equipment is allowed without Interacoustics authorization.

Interacoustics will make available on request circuit diagrams, component part lists, descriptions, calibration instructions, or other information that will assist service personnel to repair those parts of this audiometer that are designated by the Interacoustics as repairable by service personnel



Never insert or in any way use the insert headset without a new clean non defect test tip. Always make sure that foam or ear-tip is mounted correctly. Ear tips and foam are single use.

The instrument is not intended to be used in environments exposed to fluid spills.

It is recommended that the disposable foam ear tips supplied with the optional EarTone5A insert transducers are replaced after each patient tested. Disposable plugs also ensure that sanitary conditions exist for each of your patients, and that periodic cleaning of a headband or cushion is no longer required.

- The black tubing protruding the foam ear tip is attached to the sound tube nipple of the insert transducer
- Roll the foam tip into the smallest possible diameter
- Insert into the ear canal of the patient
- Hold the foam tip until expanded and a seal is achieved
- After testing the patient, the foam tip including the black tubing is detached from the sound tube nipple
- The insert transducer should be examined prior to attaching a new foam tip

The instrument is not intended to be used in oxygen rich environments or use in conjunction with flammable agents

NOTICE

To prevent system faults, take appropriate precautions to avoid PC viruses and similar.

Use only transducers calibrated with actual instrument. To identify a valid calibration, the serial number for the instrument will be marked on the transducer.

Although the instrument fulfils the relevant EMC requirements precautions should be taken to avoid unnecessary exposure to electromagnetic fields, e.g. from mobile phones etc. If the device is used adjacent to other equipment it must be observed that no mutual disturbance appears. Please also refer to EMC consideration in the appendix.



Within the European Union it is illegal to dispose electric and electronic waste as unsorted municipal waste. Electric and electronic waste may contain hazardous substances and therefore have to be collected separately. Such products will be marked with the crossed-out wheeled bin shown below. The cooperation of the user is important in order to ensure a high level of reuse and recycling of electric and electronic waste. Failing to recycle such waste products in an appropriate way may endanger the environment and consequently the health of human beings.

To prevent system faults, take appropriate precautions to avoid PC viruses and similar.

Remove the batteries in the bottom if the instruments will not be used for some time.

2.4 Malfunction



In the event of a product malfunction, it is important to protect patients, users, and other persons against harm. Therefore, if the product has caused, or potentially could cause such harm, it must be quarantined immediately.

Both harmful and harmless malfunctions, related to the product itself or to its use, must immediately be reported to the distributor where the product was acquired. Please remember to include as many details as possible e.g. the type of harm, serial number of the product, software version, connected accessories and any other relevant information.

In case of death or serious incident in relation to the use of the device, the incident must immediately be reported to Interacoustics and the local national competent authority.



3 Getting started - setup and installation

3.1 Back panel connections – Standard accessories

When connecting to back panel connections tilt up/turn the instrument carefully for better overview.

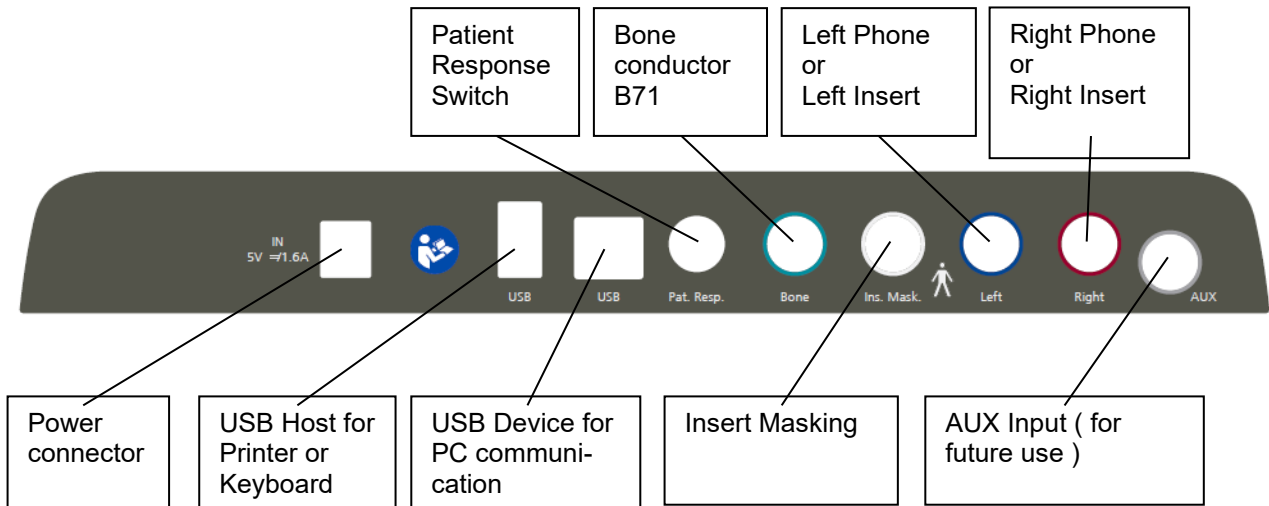



3.2 PC-interface

Please refer to the Diagnostic Suite operation manual regarding hybrid mode (on-line and PC-operated mode) as well as patient/session data transfer.

NOTICE: As a part of data protection, ensure to be compliant to all the following points:

1. Use Microsoft supported operating systems
2. Ensure operating systems are security patched
3. Enable database encryption
4. Use individual user accounts and passwords
5. Secure physical and network access to computers with local data storage
6. Use updated antivirus and firewall and anti-malware software
7. Implement appropriate backup policy
8. Implement appropriate log retention policy

3.3 About Diagnostic Suite

Should you go to Menu > Help > About then you will see the below window. This is the area of the software where you can manage license keys and check your Suite, Firmware and Build Versions.

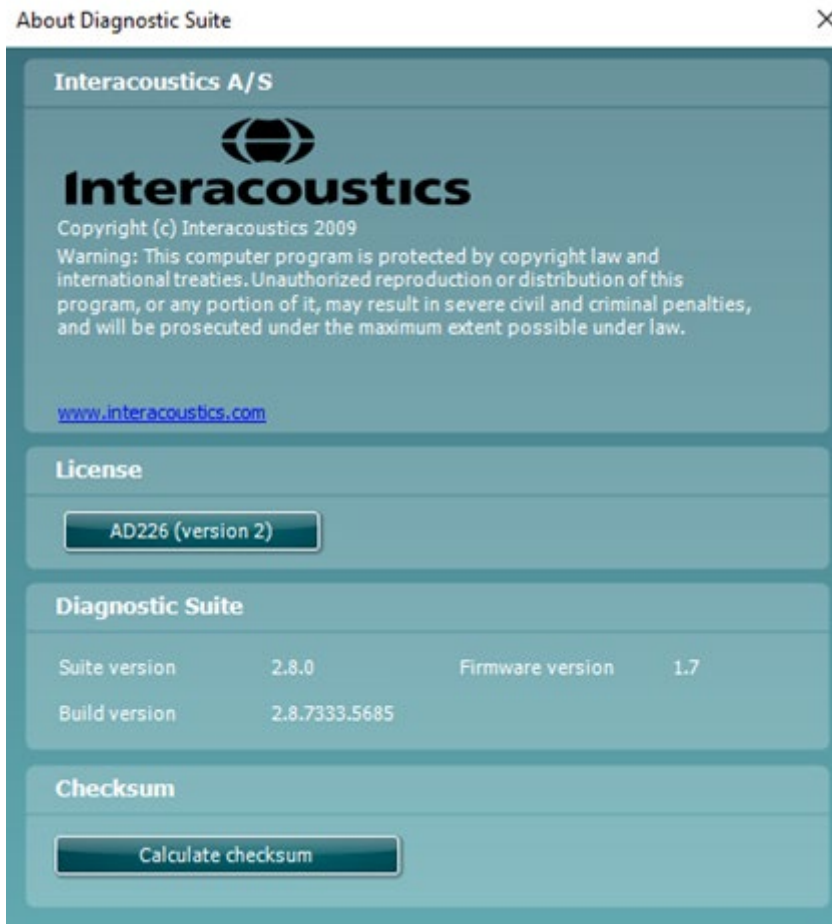

Also, in this window you will find the Checksum section which is a feature designed to help you identify the integrity of the software. It works by checking the file and folder content of your software version. This is using an SHA-256 algorithm.

On opening the checksum, you will see a string of characters and numbers, you can copy this by double clicking on it.





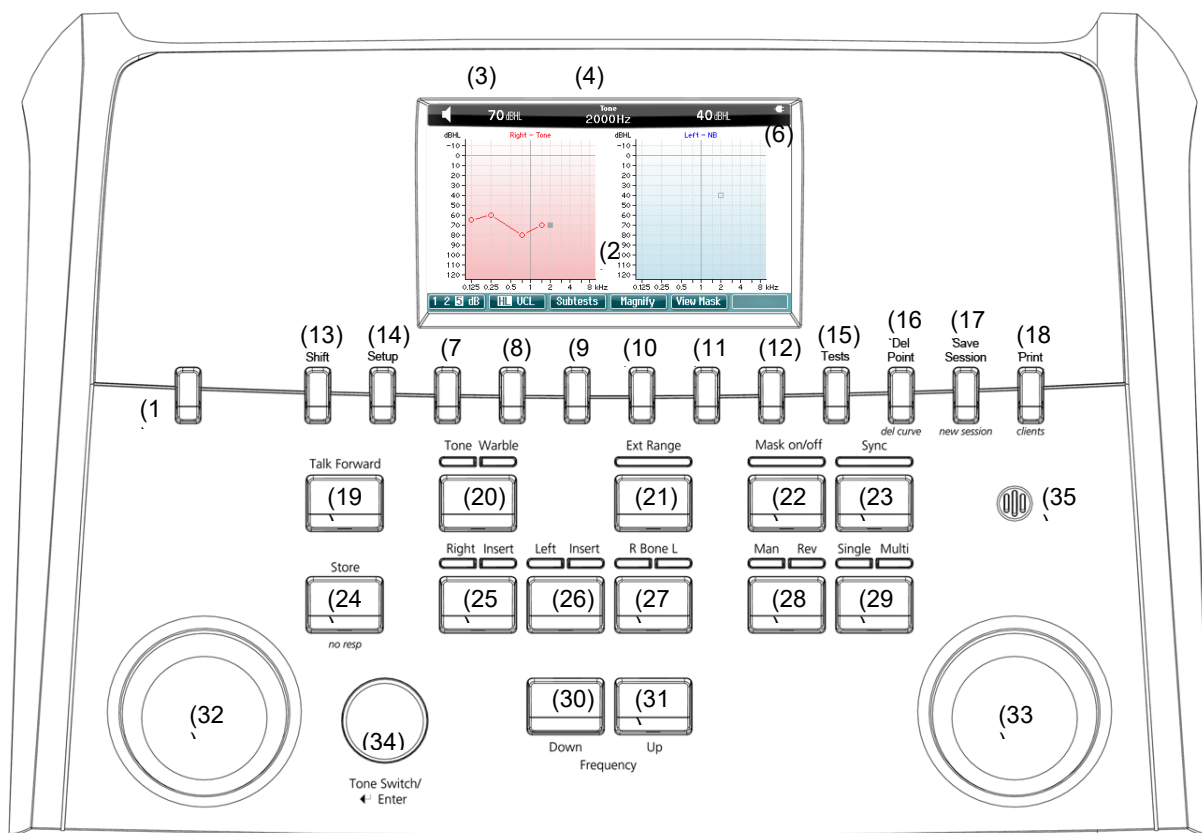

3.4 Operating instructions

The figure below shows the outline of the front plate of the AD226 including buttons, dials and display:



The following table describes the functions of the various buttons and dials.

	Name(s)/Function(s)	Description
1	Power on/off button	For turning the instrument on/off.
2	Color Display Screen	For displaying the different test screens.
3	Tone Indicator	Indication sign  seen when a tone is presented to the patient.
4	Response Indicator	Green indication sign  seen when the patient activates the patient signal using the patient response.
6	Channel 1	Indicates intensity level for channel 1, e.g.: 
6	Masking / Channel 2	Indicates masking or Intensity level for channel 2, e.g.: 
7-12	Function Keys	These keys are context sensitive and depend on the selected test screen. The functions of these keys will be explained further in later sections.



- | | | |
|----|-------------------------------------|--|
| 13 | Shift | The shift function will enable the clinician to activate the sub functions written in <i>italic</i> underneath the buttons. |
| 14 | Setup | Allows the clinician to make changes in certain settings within each test and change settings for the instrument.
Choose between the different settings using the right rotary wheel (33). Change the individual settings using the left rotary wheel (32). |
| 15 | Tests | Allows the clinician to access special tests. Hold down the “Tests” button and use one of the rotary wheels (32)/(33) to select the individual tests. |
| 16 | Del Point /
<i>del curve</i> | Delete points during testing by selecting a point using the “Down” (30) and “Up” (31) buttons and pressing the “Del Point” button. Delete the entire test curve of a graph by holding “Shift” (13) and pressing the “Del Point” button. |
| 17 | Save Session/
<i>New Session</i> | Save a session after testing or alternatively create a new session by holding “Shift” (13) and pressing the “Save Session” button. In the Save Session menu it is possible to save sessions, delete and create clients and edit client names.
The maximum capacity is 200 clients. By choosing the “About” tab in the Setup menu it is possible to see available client storage space.
Please see section below for a screenshot of the Save Session dialog. |
| 18 | Print
<i>Clients</i> | Allows results to be printed directly after testing (via a supported USB printer). Hold ”Shift” (13) and press “Print” to access the clients and sessions stored on the device. |
| 19 | Talk Forward | Instruction to the patient directly through his headphones via the microphone (35) can be given. The intensity changes by turning the “HL dB” (32) while holding the “Talk Forward” button. |

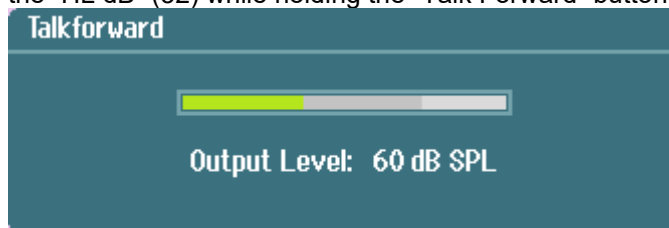

- | | | |
|----|---------------|--|
| 20 | Tone / Warble | Pure tones or warble tones can be chosen as stimuli by activating this button once or twice. The stimulus chosen will be shown on the display, e.g.: |
|----|---------------|--|

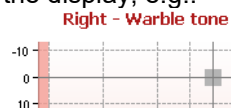

- | | | |
|----|-------------|--|
| 21 | Ext Range | Extended Range: Usually the maximum output is e.g. 100dB but if a higher output e.g. 120 dB is needed then “Ext Range” can be activated when reaching a certain level. |
| 22 | Mask on/off | Masking channel on/off: <ul style="list-style-type: none">• First push: turns masking on• Second push: turns masking off |



23	Sync	This allows the masking attenuator to be locked to the tone attenuator. This option is used for e.g., synchronous masking.
24	Store <i>no resp</i>	Use this function to store test thresholds / results. Press “Shift” (13) + “Store” to use the No Response function if the patient has shown no response to stimuli.
25	Right	For selecting the right ear during testing.
26	Left	For selecting the left ear during testing.
27	R Bone L	For bone conduction testing (can only be selected when calibrated). <ul style="list-style-type: none">• First push: selects the right ear for testing.• Second push: selects the left ear for testing.
28	Man / Rev	Manual / Reverse tone presentation modes: <ul style="list-style-type: none">• First push: Manual tone presentation each time “Tone Switch” (34) is activated.• Second push: The reverse function- continuous tone presentation which will be interrupted each time “Tone Switch” (34) is activated.
29	Single / Multi	Pulsing modes: <ul style="list-style-type: none">• First push: the tone presented will have a pre-set length when “Tone Switch” (34) is activated. (Set up in the “Setup” (13)).• Second push: the tone will be pulsing continuously.• Third push: returns back to normal mode.
30	Down	Used to decrease the frequency level.
31	Up	Used to increase the frequency level.
32	HL db Channel 1	This allows for the adjusting of the intensity in channel 1 shown at (5) in the display.
33	Masking Channel 2	Adjust the intensity level in channel 2 or masking levels when masking is used. Shown at (6) in the display.
34	Tone Switch / Enter	Used for tone presentation where the “Tone” indication sign (3) will show. Can also be used as “Enter” (selection) button.
35	Microphone	For talk forward instruction to the patient.



Battery operation

Insert batteries correct according to marking.

Use 4x1.5V/1.2V Alkaline/NiMH Type AA

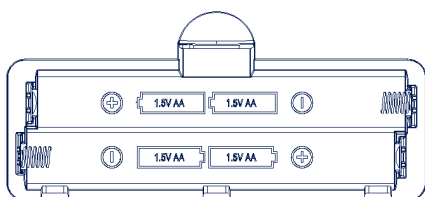

Note:

When the instrument is battery powered or USB-only powered the maximum stimuli output level is reduced 20dB

3.5 Tone test

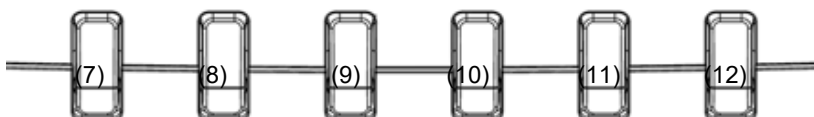
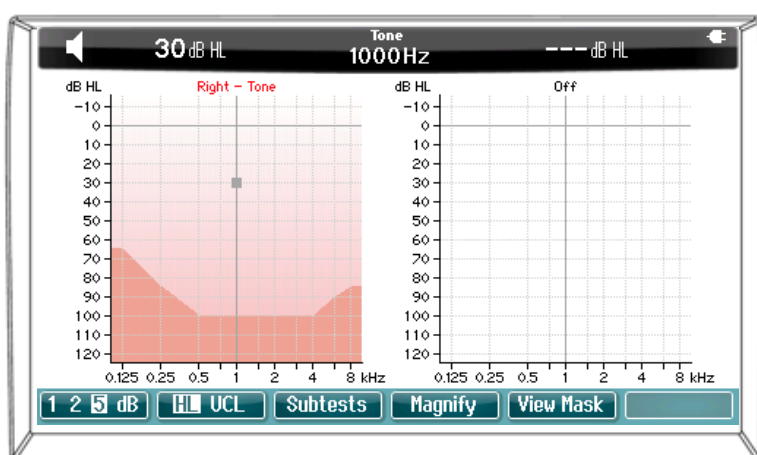

	Text on screen	Description
7	1 2 5 dB	Choose between 1, 2 and 5 dB intervals when adjusting the intensity levels in channel 1 and 2 or adjusting the masking level when masking is used.
8	HL UCL	Choose between HL and UCL.
9	Subtests	Choose the different subtests, Stenger and ABLB by holding the Function Key (9) and choosing the required test by using one of the rotary wheels (32)/(33)
10	Magnify	Switch between magnified top bar and normal sized top bar.
11	View Mask	View the masking levels when masking is on by holding the Function Key (11)



3.6 Stenger test

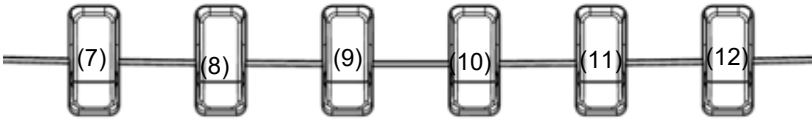
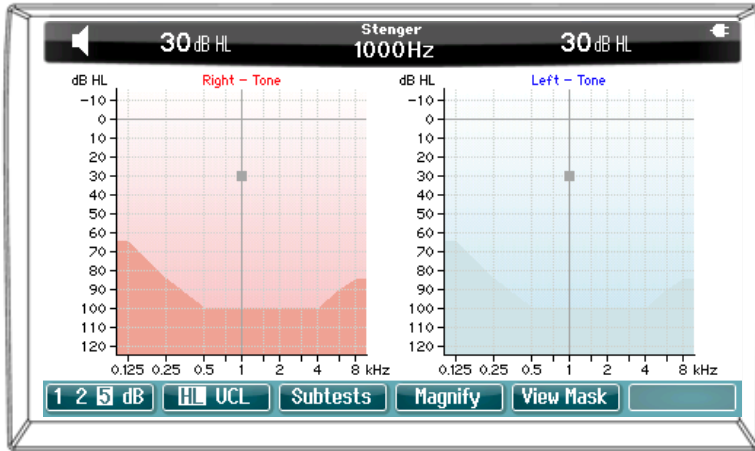

Please refer to the Tone Test section above for key function descriptions for Function Keys (7), (8), (9), (10).

3.7 ABLB test

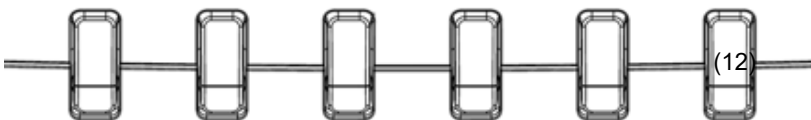
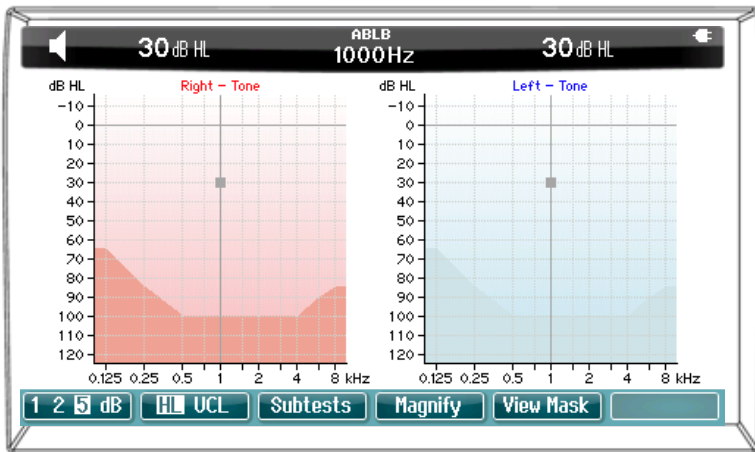

Please refer to the Tone Test section above for key function descriptions for Function Keys (7), (8), (9), (10).



3.8 Hughson-Westlake test

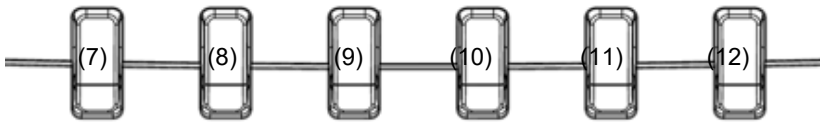
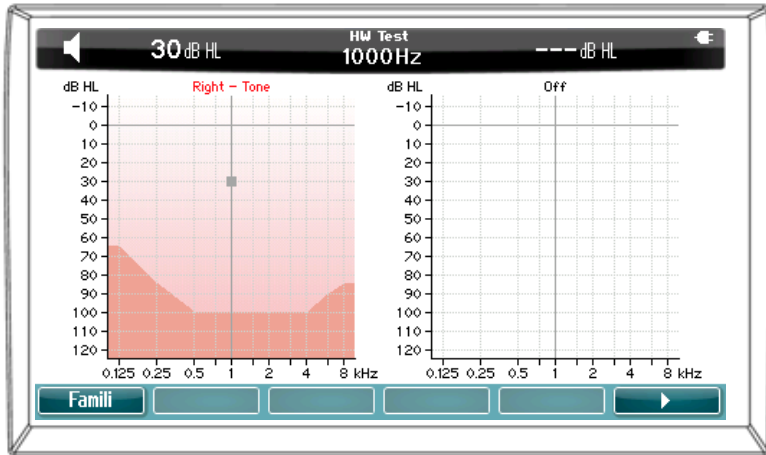

Text on screen **Description**

- | | | |
|----|--------|--------------------|
| 7 | Famili | Select familiarity |
| 12 | ▷ | Start HW test |

3.8.1 Hughson-Westlake setup

Hughson-Westlake threshold method



Toggle between “2 correct out of 3 answers” and “3 correct out of 5 answers”. The conditions used before going to the next frequency.



Hughson-Westlake stimulus on time

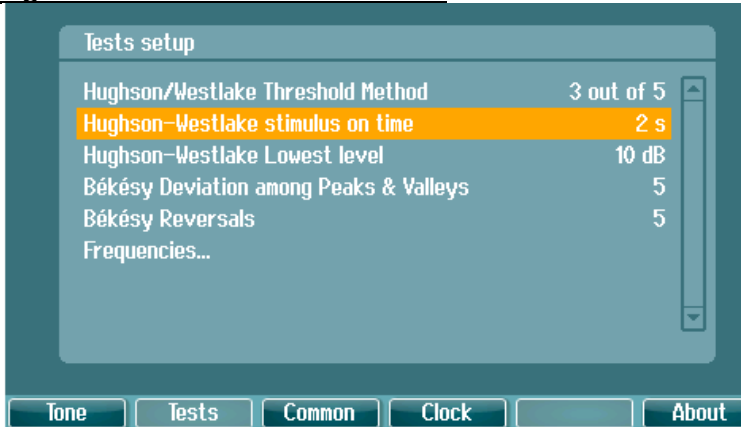

Set the stimulus on time to 1 or 2 seconds.

Hughson-Westlake lowest level

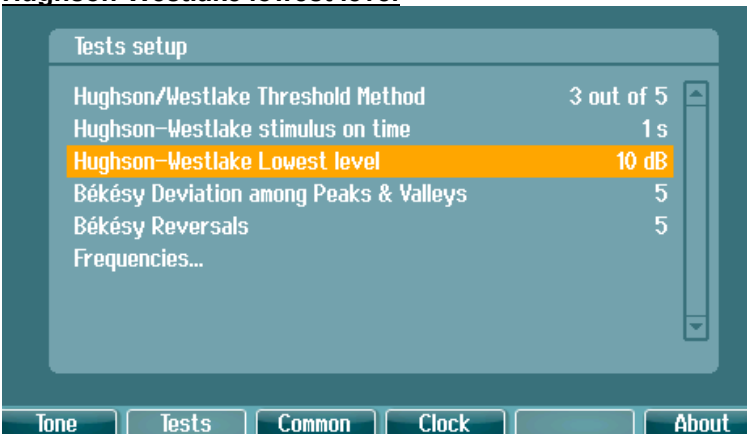

Set the lower limit and determine when to move on to the next frequency. The lower limit can be set between -10 and 20 dB.

Setup

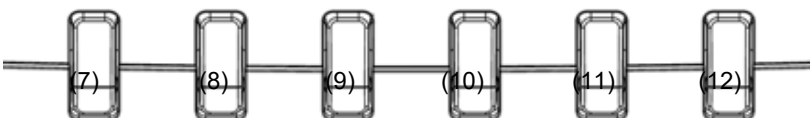
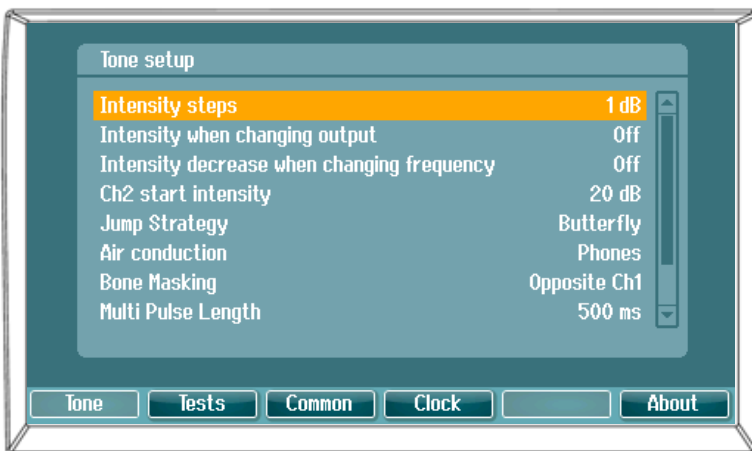



3.9 Sessions and clients

3.9.1 Save session

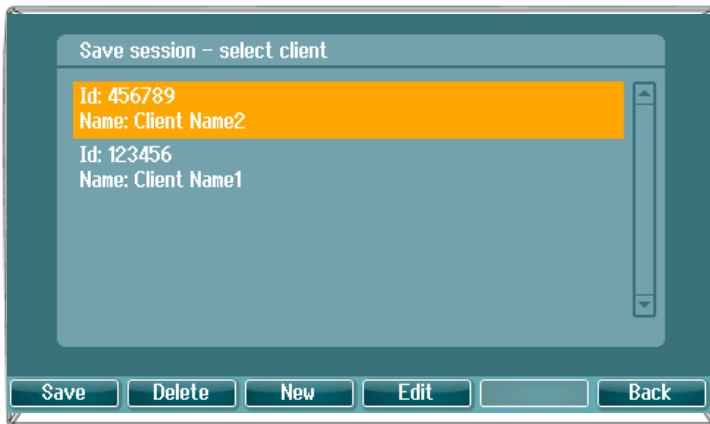

Text on screen	Description
----------------	-------------

7	Save	Save session under the selected client.
8	Delete	Delete the selected client.
9	New	Create new client.
10	Edit	Edit the selected client.
12	Back	Go back to the session.

3.9.2 View client

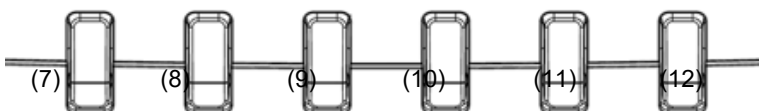

Text on screen	Description
----------------	-------------

Session	Open the View Session – Select Session menu and access or delete the session(s) saved under the selected client.
Back	Go back to the session.



4 Care and maintenance

4.1 General maintenance procedures

It is recommended that routine check procedures are carried out weekly in full on all equipment in use. Check 1-9 outlined below should be followed on the equipment on each day of use.

The purpose of routine checking is to ensure that the equipment is working properly, that its calibration has not noticeably changed, and that its transducers and connections are free from any defect that might adversely affect the test result. The checking procedures should be carried out with the audiometer set up in its usual working situation. The most important elements in daily performance checks are the subjective tests and these tests can only be successfully carried out by an operator with unimpaired and preferably known good hearing. If a booth or separate test room is used, the equipment should be checked as installed; an assistant may be required in order to carry out the procedures. The checks will then cover the inter-connections between the audiometer and the equipment in the booth, and all connecting leads, plugs, and socket connections at the junction box (sound room wall) should be examined as potential sources of intermittency or incorrect connection. The ambient noise conditions during the tests should not be substantially worse than those encountered when the equipment is in use.

- 1) Clean and examine the audiometer and all accessories.
- 2) Check earphone cushions, plugs, main leads and accessory leads for signs of wear or damage. Damaged or badly worn parts should be replaced.
- 3) Switch on equipment and leave for the recommended warm-up time. Carry out any set-up adjustments as specified. On battery-powered equipment, check battery state using the manufacturer's specified method. Switch on equipment and leave for the recommended warm-up time. If no warm-up period is quoted, allow 5 min for circuits to stabilize. Carry out any setting-up adjustments as specified. On battery-powered equipment, check battery state.
- 4) Check that earphone and bone vibrator serial numbers are correct for use with the audiometer.
- 5) Check that audiometer output is approximately correct on both air and bone conduction by conducting a simplified audiogram on a known test subject with known hearing; check for any change.
- 6) Check at high level (for example hearing levels of 60 dB on air conduction and 40 dB on bone conduction) on all appropriate functions (and on both earphones) at all frequencies used; listen for proper functioning, absence of distortion, freedom from clicks, etc.
- 7) Check all earphones (including masking transducer) and the bone vibrator for absence of distortion and intermittency; check plugs and leads for intermittency.
- 8) Check that all switch knobs are secure and that indicators work correctly.
- 9) Check that the subject's signal system operates correctly.
- 10) Listen at low levels for any sign of noise, hum, or unwanted sounds (break-through arising when a signal is introduced in another channel) or for any change in tone quality as masking is introduced.
- 11) Check that attenuators do attenuate the signals over their full range and that attenuators which are intended to be operated while a tone is being delivered are free from electrical or mechanical noise.
- 12) Check that controls operate silently and that no noise radiated from the audiometer is audible at the subject's position.
- 13) Check subject communication speech circuits, if appropriate, applying procedures similar to those used for pure-tone function.
- 14) Check tension of headset headband and bone vibrator headband. Ensure that swivel joints are free to return without being excessively slack.
- 15) Check headbands and swivel joints on noise-excluding headsets for signs of wear strain or metal fatigue.



The instrument had been designed to provide many years of reliable service, but annual calibration is recommended due to possible impact on transducers.

We also required –recalibrating of the instrument; if something drastic happens to a part of it (e.g. headset or bone conductor is dropped on a hard surface).

Calibration procedure is available in service manual which is available on request.

NOTICE

Great care should be exercised by the handling of earphones and other transducers, as mechanical shock may cause change of calibration.

4.2 How to clean Interacoustics Products

If the surface of the instrument or parts of it are contaminated, it can be cleaned using a soft cloth moistened with a mild solution of water and dish washing cleaner or similar. The use of organic solvents and aromatic oils must be avoided. Always disconnect the USB cable during the cleaning process and be careful that no fluid is entering the inside of the instrument or the accessories.



- Before cleaning always switch off and disconnect from power
- Use a soft cloth lightly dampened with cleaning solution to clean all exposed surfaces
- Do not allow liquid to come in contact with the metal parts inside the earphones / headphones
- Do not autoclave, sterilize or immerse the instrument or accessory in any fluid
- Do not use hard or pointed objects to clean any part of the instrument or accessory
- Do not let parts that have been in contact with fluids dry before cleaning
- Rubber ear-tips or foam ear-tips are single use components

Recommended cleaning and disinfection solutions:

- Warm water with mild, nonabrasive cleaning solution (soap)

Procedure:

- Clean the instrument by wiping outer case with a lint free cloth lightly dampened in cleaning solution
- Clean cushions and patient hand switch and other parts with a lint free cloth lightly dampened in cleaning solution
- Make sure not to get moisture in the speaker portion of the earphones and similar parts

4.3 Concerning repair

Interacoustics is only considered to be responsible for the validity of the CE marking, effects on safety, reliability, and performance of the equipment if:

1. assembly operations, extensions, readjustments, modifications, or repairs are carried out by authorised persons,
2. a 1 year service interval is maintained
3. the electrical installation of the relevant room complies with the appropriate requirements, and
4. the equipment is used by authorised personnel in accordance with the documentation supplied by Interacoustics.



The customer shall reach out to the local distributor to determine the service/repair possibilities including onsite service/repair. It is important that the customer (through local distributor) fills out the **RETURN REPORT** every time when the component/product is sent for service/repair to Interacoustics.

4.4 Warranty

INTERACOUSTICS warrants that:

- The AD226 is free from defects in material and workmanship under normal use and service for a period of 12 months from the date of delivery by Interacoustics to the first purchaser
- Accessories are free from defects in material and workmanship under normal use and service for a period of ninety (90) days from the date of delivery by Interacoustics to the first purchaser

If any product requires service during the applicable warranty period, the purchaser should communicate directly with the local Interacoustics service centre to determine the appropriate repair facility. Repair or replacement will be carried out at Interacoustics' expense, subject to the terms of this warranty. The product requiring service should be returned promptly, properly packed, and postage prepaid. Loss or damage in return shipment to Interacoustics shall be at purchaser's risk.

In no event shall Interacoustics be liable for any incidental, indirect or consequential damages in connection with the purchase or use of any Interacoustics product.

This shall apply solely to the original purchaser. This warranty shall not apply to any subsequent owner or holder of the product. Furthermore, this warranty shall not apply to, and Interacoustics shall not be responsible for, any loss arising in connection with the purchase or use of any Interacoustics product that has been:

- repaired by anyone other than an authorized Interacoustics service representative;
- altered in any way so as, in Interacoustics judgement, to affect its stability or reliability;
- subject to misuse or negligence or accident, or which has had the serial or lot number altered, effaced, or removed; or
- improperly maintained or used in any manner other than in accordance with the instructions furnished by Interacoustics.

This warranty is in lieu of all other warranties, express or implied, and of all other obligations or liabilities of Interacoustics, and Interacoustics does not give or grant, directly or indirectly, the authority to any representative or other person to assume on behalf of Interacoustics any other liability in connection with the sale of Interacoustics products.

INTERACOUSTICS DISCLAIMS ALL OTHER WARRANTIES, EXPRESSED OR IMPLIED, INCLUDING ANY WARRANTY OF MERCHANTABILITY OR FOR FUNCTION OF FITNESS FOR A PARTICULAR PURPOSE OR APPLICATION.



5 General technical specifications

AD226 Technical specification

Safety Standards	IEC 60601-1:2005, ES60601-1:2005/A2:2010, CAN/CSA-C22.2 No 60601-1-:2008 Class I, Type B applied parts.	
EMC Standard	IEC 60601-1-2:2007	
Medical CE-mark	Yes	
Audiometer Standards	Tone: IEC 60645-1:2012/ANSI S3.6:2010 Type 3	
Calibration	Calibration information and instructions is located in the AD226 Service manual	
Air Conduction	TDH39: DD45: E.A.R Tone 3A: IP30 DD450 DD65 v2	ISO 389-1 1998, ANSI S3.6-2010 ANSI S3.6 2018 / ISO 389-1 2017 ISO 389-2 1994, ANSI S3.6-2010 ISO 389-2 1994, ANSI S3.6-2018 ANSI S3.6 – 2018 ANSI S3.6 2018
Bone Conduction	B71: Placement:	ISO 389-3 1994, ANSI S3.6-2010 Mastoid
Effective masking	ISO 389-4 1994, ANSI S3.6-2010	
Transducers	TDH39 DD45 B71 Bone DD450 E.A.R Tone 3A: IP30 DD65 v2	Headband Static Force 4.5N ±0.5N Headband Static Force 4.5N ±0.5N Headband Static Force 5.4N ±0.5N Headband Static Force 10N ±0.5N Headband Static Force 11.5N ±0.5N
Patient Response switch	One push button.	
Patient communication	Talk Forward (TF)	
Special tests/test battery (only extended version)	<ul style="list-style-type: none"> • Stenger • ABLB • Langenbeck (tone in noise). • SISI • Auto threshold: <ul style="list-style-type: none"> ○ Hughson Westlake ○ Békésy 	
Inputs	Tone, Warble Tone +5%, 5Hz (true sine wave frequency modulation).	
Outputs	Left, Right, Bone L+R, Insert Phones, Insert Masking	
Stimuli		
Tone	125-8000Hz.	
Warble Tone	5Hz sine +/- 5% modulation	
Masking	Narrow band noise: IEC 60645-1 2012, 5/12 Octave filter with the same centre frequency resolution as pure Tone. Synchronous masking: Locks channel 2 attenuator to channel 1 attenuator.	
Presentation	Manual or Reverse. Single pulse. Multiple pulses 50-5000 msec. on/off.	



Intensity	AC: -10 to 120 dB HL BC: -10 to 80 dB Available Intensity Steps is 1, 2 or 5dB Extended range function: If not activated, the Air Conduction output will be limited to 20 dB below maximum output. Extended range only available when mains powered
Frequency range	125Hz to 8kHz. 125Hz, 250Hz, 500 Hz, 750Hz, 1500Hz or 8kHz may freely be deselected
Internal storage	500 clients
Data Connections (sockets) for connection of accessories	1 x USB A for keyboard or printer 1 x USB B for PC connection (compatible with USB 1.1 and later)
External devices (USB)	Standard PC keyboard (for data entry) Supported printers: Please contact local distributor for a list of approved PC printers.
Display	4,3" (480x278) TFT color display.
Compatible software (optional)	Diagnostic Suite - Noah, OtoAccess® and XML compatible
Dimensions (LxWxH)	30x23x9cm, 12x9x4 inches.
Weight	1.3kg / 2.9lb
Power supply	5VDC-max 1.6A UE24 type only
Batteries	4x1.5V/1.2V Alkaline/NiMH Type AA, Note: When the instrument is battery operated the maximum stimuli output level is reduced 20dB
Operation environment	Temperature: 15-35°C Re. Humidity: 30-90% Non condensing Ambient pressure: 98-104 kPa
Transport and storage	Transport temperature: -20-50°C Storage temperature: 0-50°C Re. Humidity: 10-95% Non condensing
Warm up time	Approx. 1 minute

5.1 Reference Equivalent Threshold Values for transducers

See Appendix in the back of the manual.

5.2 Pin Assignments

See Appendix in the back of the manual.

5.3 Electromagnetic Compatibility (EMC)

See Appendix in the back of the manual.

5.1 Survey of Reference and max Hearing Level Tone Audiometer

ANSI TDH39				
Coupler: ANSI S3.7-1995 (NBS-9A) / IEC 60318-3 1998 (6ccm)				
Tone Audiometer				
Frequency	Tone		Narrow Band Noise	
	ANSI S3.6-2010		ANSI S3.6-2010	
	RETSPL	MaxHL	RETSPL	MaxHL
125	45.0	85	49.0	65
160 ¹	37.5	90	41.5	75
200 ¹	31.5	95	35.5	80
250	25.5	105	29.5	85
315 ¹	20.0	110	24.0	90
400 ¹	15.0	115	19.0	95
500	11.5	120	15.5	100
630 ¹	8.5	120	13.5	105
750	8.0	120	13.0	105
800 ¹	7.0	120	12.0	105
1000	7.0	120	13.0	105
1250 ¹	6.5	120	12.5	105
1500	6.5	120	12.5	105
1600 ¹	7.0	120	13.0	105
2000	9.0	120	15.0	105
2500 ¹	9.5	120	15.5	105
3000	10.0	120	16.0	105
3150 ¹	10.0	120	16.0	105
4000	9.5	120	14.5	105
5000 ¹	13.0	120	18.0	105
6000	15.5	110	20.5	95
6300 ¹	15.0	110	20.0	95
8000	13.0	105	18.0	95
WhiteNoise			0.0	120
TenNoise			25.0	110

¹ The RETSPL is copy from ISO389-1 1998

IEC TDH39				
Coupler: IEC 60318-3 1998 (6ccm)				
Tone Audiometer				
Frequency	Tone		Narrow Band Noise	
	ISO 389-1 1998		ISO 389-4 1994	
	RETSPL	MaxHL	RETSPL	MaxHL
125	45.0	85	49.0	65
160	37.5	90	41.5	75
200	31.5	95	35.5	80
250	25.5	105	29.5	85
315	20.0	110	24.0	90
400	15.0	115	19.0	95
500	11.5	120	15.5	100
630	8.5	120	13.5	105
750	7.5	120	12.5	105
800	7.0	120	12.0	105
1000	7.0	120	13.0	105
1250	6.5	120	12.5	105
1500	6.5	120	12.5	105
1600	7.0	120	13.0	105
2000	9.0	120	15.0	105
2500	9.5	120	15.5	105
3000	10.0	120	16.0	105
3150	10.0	120	16.0	105
4000	9.5	120	14.5	105
5000	13.0	120	18.0	105
6000	15.5	110	20.5	95
6300	15.0	110	20.0	95
8000	13.0	105	18.0	95
WhiteNoise			0.0	120
TenNoise			25.0	110

ANSI DD45				
Coupler: ANSI S3.7-1995 (NBS-9A) / IEC 60318-3 1998 (6ccm)				
Tone Audiometer				
Frequency	Tone		Narrow Band Noise	
	ANSI S3.6-2010		ANSI S3.6-2010	
	RETSPL	MaxHL	RETSPL	MaxHL
125	47.5	85	51.5	65
160 ¹	40.5	90	44.5	75
200 ¹	33.5	95	37.5	80
250	27	105	31	85
315 ¹	22.5	110	26.5	90
400 ¹	17.5	115	21.5	95
500	13	120	17	100
630 ¹	9	120	14	105
750	6.5	120	11.5	105
800 ¹	6.5	120	11.5	105
1000	6	120	12	105
1250 ¹	7	120	13	105
1500	8	120	14	105
1600 ¹	8	120	14	105
2000	8	120	14	105
2500 ¹	8	120	14	105
3000	8	120	14	105
3150 ¹	8	120	14	105
4000	9	120	14	105
5000 ¹	10	120	15	105
6000	20.5	110	25.5	95
6300 ¹	19	110	24	95
8000	12	105	17	95
WhiteNoise			0.0	120
TenNoise			25.0	110

¹ The RETSPL is copy from ISO389-1 1998

IEC DD45				
Coupler: IEC 60318-3 1998 (6ccm)				
Tone Audiometer				
Frequency	Tone		Narrow Band Noise	
	ISO 389-1 1998		ISO 389-4 1994	
	RETSPL	MaxHL	RETSPL	MaxHL
125	47.5	85	51.5	65
160	40.5	90	44.5	75
200	33.5	95	37.5	80
250	27	105	31	85
315	22.5	110	26.5	90
400	17.5	115	21.5	95
500	13	120	17	100
630	9	120	14	105
750	6.5	120	11.5	105
800	6.5	120	11.5	105
1000	6	120	12	105
1250	7	120	13	105
1500	8	120	14	105
1600	8	120	14	105
2000	8	120	14	105
2500	8	120	14	105
3000	8	120	14	105
3150	8	120	14	105
4000	9	120	14	105
5000	10	120	15	105
6000	20.5	110	25.5	95
6300	19	110	24	95
8000	12	105	17	95
WhiteNoise			0.0	120
TenNoise			25.0	110

ANSI DD65 v2				
Coupler: ANSI S3.7-1995 (NBS-9A) / IEC 60318-3 1998 (6ccm)				
Tone Audiometer				
	Tone		Narrow Band Noise	
	ANSI S3.6 2018		ANSI S3.6 2018	
Frequency	RETSPL	MaxHL	RETSPL	MaxHL
125	30,5	85	34,5	70
250	17	100	21	85
500	8	110	12	95
750	5,5	115	10,5	100
1000	4,5	115	10,5	100
1500	2,5	115	8,5	100
2000	2,5	115	8,5	95
3000	2	115	8	100
4000	9,5	110	14,5	95
6000	21	100	26	85
8000	21	95	26	80

ANSI EAR 3A					
Coupler: ANSI S3.7-1995 (HA-2 with 5mm rigid Tube)					
Tone Audiometer					
Frequency	Tone		Narrow Band Noise		
	ANSI S3.6-2010		ANSI S3.6-2010		
	RETSPL	MaxHL	RETSPL	MaxHL	MaxHL
125	26.0	90	30.0	85	
160	22.0	95	26.0	90	
200	18.0	100	22.0	95	
250	14.0	105	18.0	100	
315	12.0	105	16.0	100	
400	9.0	110	13.0	100	
500	5.5	110	9.5	105	
630	4.0	115	9.0	105	
750	2.0	115	7.0	110	
800	1.5	115	6.5	110	
1000	0.0	120	6.0	110	
1250	2.0	120	8.0	110	
1500	2.0	120	8.0	110	
1600	2.0	120	8.0	110	
2000	3.0	120	9.0	110	
2500	5.0	120	11.0	110	
3000	3.5	120	9.5	110	
3150	4.0	120	10.0	110	
4000	5.5	115	10.5	110	
5000	5.0	105	10.0	105	
6000	2.0	100	7.0	100	
6300	2.0	100	7.0	95	
8000	0.0	90	5.0	95	
WhiteNoise			0.0	110	

IEC EAR 3A				
Coupler: IEC 60318-5 2006				
Tone Audiometer				
Frequency	Tone		Narrow Band Noise	
	ISO 389-2 1994		ISO 389-4 1994	
	RETSPL	MaxHL	RETSPL	MaxHL
125	26.0	90	30.0	85
160	22.0	95	26.0	90
200	18.0	100	22.0	95
250	14.0	105	18.0	100
315	12.0	105	16.0	100
400	9.0	110	13.0	100
500	5.5	110	9.5	105
630	4.0	115	9.0	105
750	2.0	115	7.0	110
800	1.5	115	6.5	110
1000	0.0	120	6.0	110
1250	2.0	120	8.0	110
1500	2.0	120	8.0	110
1600	2.0	120	8.0	110
2000	3.0	120	9.0	110
2500	5.0	120	11.0	110
3000	3.5	120	9.5	110
3150	4.0	120	10.0	110
4000	5.5	115	10.5	105
5000	5.0	105	10.0	100
6000	2.0	100	7.0	95
6300	2.0	100	7.0	95
8000	0.0	90	5.0	95
WhiteNoise			0.0	110

ANSI B71				
Coupler 60318-6 2007				
Tone Audiometer				
Frequency	Tone		Narrow Band Noise	
	ISO 389-3 1994		ISO 389-4 1994	
	RETSPL	MaxHL	RETSPL	MaxHL
125	-	-	-	-
160	-	-	-	-
200	-	-	-	-
250	67.0	45	71.0	30
315	64.0	50	68.0	35
400	61.0	65	65.0	50
500	58.0	65	62.0	50
630	52.5	70	57.5	55
750	48.5	70	53.5	55
800	47.0	70	52.0	55
1000	42.5	70	48.5	55
1250	39.0	70	45.0	55
1500	36.5	70	42.5	55
1600	35.5	70	41.5	55
2000	31.0	75	37.0	60
2500	29.5	75	35.5	65
3000	30.0	75	36.0	65
3150	31.0	75	37.0	65
4000	35.5	75	40.5	65
5000	40.0	55	45.0	45
6000	40.0	45	45.0	40
6300	40.0	45	45.0	35
8000	40.0	45	45.0	35
WhiteNoise			42.5	70

IEC B71				
Coupler 60318-6 2007				
Tone Audiometer				
Frequency	Tone		Narrow Band Noise	
	ISO 389-3 1994		ISO 389-4 1994	
	RETSPL	MaxHL	RETSPL	MaxHL
125	-	-	-	-
160	-	-	-	-
200	-	-	-	-
250	67.0	45	71.0	30
315	64.0	50	68.0	35
400	61.0	65	65.0	50
500	58.0	65	62.0	50
630	52.5	70	57.5	55
750	48.5	70	53.5	55
800	47.0	70	52.0	55
1000	42.5	70	48.5	55
1250	39.0	70	45.0	55
1500	36.5	70	42.5	55
1600	35.5	70	41.5	55
2000	31.0	75	37.0	60
2500	29.5	75	35.5	65
3000	30.0	75	36.0	65
3150	31.0	75	37.0	65
4000	35.5	75	40.5	65
5000	40.0	55	45.0	45
6000	40.0	45	45.0	40
6300	40.0	45	45.0	35
8000	40.0	45	45.0	35
WhiteNoise			42.5	70

ANSI CIR 22/CIR33				
Coupler ANSI S3.7-1995 (HA-2)				
Tone Audiometer				
Frequency	Tone		Narrow Band Noise	
	ANSI S3.6-2010 RET SPL	Max HL	ANSI S3.6-2010 RET SPL	Max HL
125	26.0	90	30.0	90
160	22.0	95	26.0	95
200	18.0	100	22.0	100
250	14.0	105	18.0	105
315	12.0	105	16.0	105
400	9.0	110	13.0	105
500	5.5	110	9.5	110
630	4.0	115	9.0	110
750	2.0	115	7.0	110
800	1.5	115	6.5	110
1000	0.0	120	6.0	110
1250	2.0	120	8.0	110
1500	2.0	120	8.0	110
1600	2.0	120	8.0	110
2000	3.0	120	9.0	110
2500	5.0	120	11.0	110
3000	3.5	120	9.5	110
3150	4.0	120	10.0	110
4000	5.5	115	10.5	105
5000	5.0	105	10.0	95
6000	2.0	100	7.0	95
6300	2.0	100	7.0	95
8000	0.0	90	5.0	90
WhiteNoise			0.0	110



IEC CIR 22/CIR33				
Coupler IEC 60318-5 2006 2ccm				
Tone Audiometer				
Frequency	Tone		Narrow Band Noise	
	ISO 389-2 1994 RET SPL	Max HL	ISO 389-4 1994 RET SPL	Max HL
125	26.0	90	30.0	90
160	22.0	95	26.0	95
200	18.0	100	22.0	100
250	14.0	105	18.0	105
315	12.0	105	16.0	105
400	9.0	110	13.0	105
500	5.5	110	9.5	110
630	4.0	115	9.0	110
750	2.0	115	7.0	110
800	1.5	115	6.5	110
1000	0.0	120	6.0	110
1250	2.0	120	8.0	110
1500	2.0	120	8.0	110
1600	2.0	120	8.0	110
2000	3.0	120	9.0	110
2500	5.0	120	11.0	110
3000	3.5	120	9.5	110
3150	4.0	120	10.0	110
4000	5.5	115	10.5	105
5000	5.0	105	10.0	95
6000	2.0	100	7.0	95
6300	2.0	100	7.0	95
8000	0.0	90	5.0	90
WhiteNoise			0.0	110

General properties for earphones

Sound attenuation values for earphones		
Frequency	Attenuation	
[Hz]	DD45 or TDH39 with MX41/ AR or PN 51 cushion [dB]	EAR-Tone 3A [dB]
125	3	33,5
160	4	
200	5	
250	5	34,5
315	5	
400	6	
500	7	34,5
630	9	
750	-	
800	11	
1000	15	35,0
1250	18	
1500	-	
1600	21	
2000	26	33,0
2500	28	
3000	-	
3150	31	
4000	32	39,5
5000	29	
6000	-	
6300	26	
8000	24	43,5

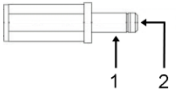
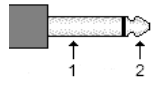
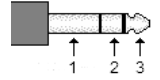
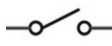
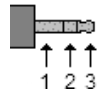
5.2 AD226 Pin assignment

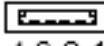
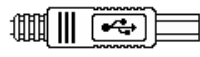
Socket	Connector	Pin 1	Pin 2	Pin 3
IN 5V  /1.6A	 DC Supply	Ground	DC	-
Left	 6.3mm Mono	Ground	Signal	-
Right				
Bone				
Ins. Mask.				
Pat. Resp.	 6.3mm Stereo	-		
AUX	 3.5mm Stereo	Ground	Signal ch. 2	Signal ch. 1

USB (host)		USB (PC)	
  4 3 2 1	1. +5 VDC	  1 2 4 3	1. +5 VDC
	2. Data -		2. Data -
	3. Data +		3. Data +
	4. Ground		4. Ground

5.3 Electromagnetic Compatibility (EMC)

- This instrument is suitable in hospital environments except for near active HF surgical equipment and RF shielded rooms of systems for magnetic resonance imaging, where the intensity of electromagnetic disturbance is high
- Use of this instrument adjacent to or stacked with other equipment should be avoided because it could result in improper operation. If such use is necessary, this instrument and the other equipment should be observed to verify that they are operating normally
- Use of accessories, transducers and cables other than those specified or provided by the manufacturer of this equipment could result in increased electromagnetic emissions or decreased electromagnetic immunity of this equipment and result in improper operation. The list of accessories, transducers and cables can be found in this appendix.
- Portable RF communications equipment (including peripherals such as antenna cables and external antennas) should be used no closer than 30 cm (12 inches) to any part of this instrument, including cables specified by the manufacturer. Otherwise, degradation of the performance of this equipment could result

NOTICE ESSENTIAL PERFORMANCE for this instrument is defined by the manufacturer as:

- This instrument does not have an ESSENTIAL PERFORMANCE Absence or loss of ESSENTIAL PERFORMANCE cannot lead to any unacceptable immediate risk
- Final diagnosis shall always be based on clinical knowledge There are no deviations from the collateral standard and allowances uses
- This instrument is in compliance with IEC60601-1-2:2014, emission class B group 1

NOTICE: There are no deviations from the collateral standard and allowances uses NOTICE: All necessary instruction for maintaining compliance with regard to EMC can be found in the general maintenance section in this instruction. No further steps required.

Portable and mobile RF communications equipment can affect the AD226. Install and operate the AD226 according to the EMC information presented in this chapter.

The AD226 has been tested for EMC emissions and immunity as a standalone instrument. Do not use the AD226 adjacent to or stacked with other electronic equipment. If adjacent or stacked use is necessary, the user should verify normal operation in the configuration.

The use of accessories, transducers and cables other than those specified, with the exception of servicing parts sold by Interacoustics as replacement parts for internal components, may result in increased EMISSIONS or decreased IMMUNITY of the device.

Anyone connecting additional equipment is responsible for making sure the system complies with the IEC 60601-1-2 standard.

Guidance and manufacturer's declaration - electromagnetic emissions		
The AD226 is intended for use in the electromagnetic environment specified below. The customer or the user of the AD226 should assure that it is used in such an environment.		
Emissions Test	Compliance	Electromagnetic environment - guidance
RF emissions CISPR 11	Group 1	The AD226 uses RF energy only for its internal function. Therefore, its RF emissions are very low and are not likely to cause any interference in nearby electronic equipment.
RF emissions CISPR 11	Class B Limits	The AD226 is suitable for use in all commercial, industrial, business, and residential environments.
Harmonic emissions IEC 61000-3-2	Complies Class A Category	
Voltage fluctuations / flicker emissions IEC 61000-3-3	Complies	

Recommended separation distances between portable and mobile RF communications equipment and the AD226.			
The AD226 is intended for use in an electromagnetic environment in which radiated RF disturbances are controlled. The customer or the user of the AD226 can help prevent electromagnetic interferences by maintaining a minimum distance between portable and mobile RF communications equipment (transmitters) and the AD226 as recommended below, according to the maximum output power of the communications equipment.			
Rated Maximum output power of transmitter [W]	Separation distance according to frequency of transmitter [m]		
	150 kHz to 80 MHz $d = 1.17\sqrt{P}$	80 MHz to 800 MHz $d = 1.17\sqrt{P}$	800 MHz to 2.5 GHz $d = 2.23\sqrt{P}$
0.01	0.12	0.12	0.23
0.1	0.37	0.37	0.74
1	1.17	1.17	2.33
10	3.70	3.70	7.37
100	11.70	11.70	23.30
For transmitters rated at a maximum output power not listed above, the recommended separation distance d in meters (m) can be estimated using the equation applicable to the frequency of the transmitter, where P is the maximum output power rating of the transmitter in watts (W) according to the transmitter manufacturer.			
Note 1 At 80 MHz and 800 MHz, the higher frequency range applies.			
Note 2 These guidelines may not apply to all situations. Electromagnetic propagation is affected by absorption and reflection from structures, objects and people.			

Guidance and Manufacturer's Declaration - Electromagnetic Immunity			
The AD226 is intended for use in the electromagnetic environment specified below. The customer or the user of the AD226 should assure that it is used in such an environment.			
Immunity Test	IEC 60601 Test level	Compliance	Electromagnetic Environment-Guidance
Electrostatic Discharge (ESD) IEC 61000-4-2	+6 kV contact +8 kV air	+6 kV contact +8 kV air	Floors should be wood, concrete or ceramic tile. If floors are covered with synthetic material, the relative humidity should be greater than 30%.
Electrical fast transient/burst IEC61000-4-4	+2 kV for power supply lines +1 kV for input/output lines	+2 kV for power supply lines +1 kV for input/output lines	Mains power quality should be that of a typical commercial or residential environment.
Surge IEC 61000-4-5	+1 kV differential mode +2 kV common mode	+1 kV differential mode +2 kV common mode	Mains power quality should be that of a typical commercial or residential environment.
Voltage dips, short interruptions and voltage variations on power supply	< 5% UT (>95% dip in UT) for 0.5 cycle	< 5% UT (>95% dip in UT) for 0.5 cycle	(>95% dip in UT) for 5 sec Mains power quality should be that of a typical

lines IEC 61000-4-11	40% <i>UT</i> (60% dip in <i>UT</i>) for 5 cycles 70% <i>UT</i> (30% dip in <i>UT</i>) for 25 cycles <5% <i>UT</i> (>95% dip in <i>UT</i>) for 5 sec	40% <i>UT</i> (60% dip in <i>UT</i>) for 5 cycles 70% <i>UT</i> (30% dip in <i>UT</i>) for 25 cycles <5% <i>UT</i>	commercial or residential environment. If the user of the AD226 requires continued operation during power mains interruptions, it is recommended that the AD226 be powered from an uninterruptable power supply or its battery.
Power frequency (50/60 Hz) IEC 61000-4-8	3 A/m	3 A/m	Power frequency magnetic fields should be at levels characteristic of a typical location in a typical commercial or residential environment.

Note: *UT* is the A.C. mains voltage prior to application of the test level.

Return Report – Form 001



Opr. dato: 2014-03-07 af: EC Rev. dato: af: MSt Rev. nr.: 4

Company: _____

Address: _____

Phone: _____

Fax or e-mail: _____

Address

10393 West 70th Street
Prairie
MN 55344
USA

Phone

(+1) 800 947 6334

Fax

(+1) 952 903 4200

E-mail

rmd@interacoustics-us.com

Contact person: _____ Date: _____

Following item is reported to be:

- returned to INTERACOUSTICS for: repair, exchange, other: _____
- defective as described below with request of assistance
- repaired locally as described below
- showing general problems as described below

Item: _____ **Type:** _____ **Quantity:** _____
Serial No.: _____ Supplied by: _____
Included parts: _____

Important! - Accessories used together with the item must be included if returned (e.g. external power supply, headsets, transducers and couplers).

Description of problem or the performed local repair:

Returned according to agreement with: Interacoustics, Other : _____

Date : _____ Person : _____

Please provide e-mail address or fax No. to whom Interacoustics may confirm reception of the returned goods:

The above mentioned item is reported to be dangerous to patient or user ¹

In order to ensure instant and effective treatment of returned goods, it is important that this form is filled in and placed together with the item.
Please note that the goods must be carefully packed, preferably in original packing, in order to avoid damage during transport. (Packing material may be ordered from Interacoustics)

¹ EC Medical Device Directive rules require immediate report to be sent, if the device by malfunction deterioration of performance or characteristics and/or by inadequacy in labelling or instructions for use, has caused or could have caused death or serious deterioration of health to patient or user. Page 1 of 1