

Science **made** smarter



Instructions for Use - US

Equinox Evo



D-0142070-B – 2025/07



Interacoustics



Copyright® Interacoustics A/S: All rights reserved. Information in this document is proprietary to Interacoustics A/S. The information in this document is subject to change without notice. No part of this document may be reproduced or transmitted in any form or by any means without a prior written permission of Interacoustics A/S.



Table of Contents

1	INTRODUCTION	5
1.1	About this manual	5
1.2	Intended use.....	5
1.3	Product description	6
1.4	Standard and optional parts.....	6
1.5	Warnings and precautions	7
2	UNPACKING AND INSTALLATION.....	8
2.1	Unpacking and inspection	8
2.2	Markings.....	9
2.3	Important safety instructions	11
2.3.1	Electrical system safety	11
2.3.2	Electrical safety	11
2.3.3	Explosion hazards	12
2.3.4	Electromagnetic compatibility (EMC).....	12
2.3.5	Cautions – General.....	12
2.3.6	Environmental factors.....	13
2.3.7	NOTICE.....	13
2.4	Malfunction	14
2.5	Disposal of the product	14
2.6	Connection panel dictionary.....	15
2.6.1	Insert masker.....	15
2.6.2	Talk Back/Ambient-Mic.....	15
2.7	Equinox Evo Indicators	16
2.8	Software installation	16
2.8.1	Software installation on Windows®11 and Windows®10	16
2.9	Driver installation.....	19
2.10	Use with databases	19
2.10.1	Noah 4.....	19
2.10.2	OtoAccess®	19
2.11	Standalone version	19
2.12	How to configure an alternative data recovery location	19
2.13	Licenses	20
2.14	About Equinox Suite.....	20
3	OPERATING INSTRUCTIONS	21
3.1	Using the tone screen	22
3.2	Using the speech screen.....	28
3.2.1	Speech audiometry in graph mode.....	30
3.2.2	Speech audiometry in table mode	31
3.3	PC keyboard shortcuts manager.....	33
3.4	Technical Specifications - AC440 software.....	35
3.5	Using the print wizard.....	37
4	TOUCH KEYBOARD (OPTIONAL)	39
4.1	Product description	39
4.2	Standard parts.....	39
4.3	Operating instructions	39
4.3.1	How to charge the Touch Keyboard	39
4.3.2	Getting ready for use.....	39
4.3.3	General functionality.....	40



4.3.4	Messages	41
4.3.5	Tone audiometry	42
4.3.6	Speech audiometry.....	44
4.3.7	Troubleshooting.....	45
4.3.8	Battery replacement	46
4.4	Touch Keyboard - Technical specifications	47
4.5	Electromagnetic compatibility (EMC) Touch Keyboard.....	48
4.6	Licenses	52
5	MAINTENANCE	53
5.1	General maintenance procedures.....	53
5.2	How to clean Interacoustics products	53
5.3	Concerning repair.....	54
5.4	Warranty.....	54
5.5	Replacement of consumables.....	55
5.5.1	Foam tips.....	55
6	GENERAL TECHNICAL SPECIFICATIONS	56
6.1	Equinox Evo - Technical Specifications	56
6.2	Tone reference equivalent threshold values for transducers.....	58
6.3	Pin assignments.....	71
6.4	Electromagnetic compatibility (EMC) Equinox Evo.....	73



1 Introduction

1.1 About this manual

This manual is valid for the Equinox Evo, software version Equinox Suite 2.24. This product is manufactured by:

Interacoustics A/S
Audiometer Allé 1
5500 Middelfart
Denmark
Tel.: +45 6371 3555
E-mail: info@interacoustics.com
Web: www.interacoustics.com

1.2 Intended use

Intended purpose

The Equinox Evo with AC440 module is an audiometer that generates specific tonal, speech and noise stimuli for audiometric tests. The behavioural response of the subject can be recorded automatically or manually depending on the audiometric test.

Intended clinical benefits

No clinical benefits.

Intended user

The Equinox Evo is intended to be used by trained personnel only, such as audiologists, ENT surgeons, doctors, hearing healthcare professionals or personnel with a similar level of education. The device should not be used without the necessary knowledge and training to understand its use and how results should be interpreted.

Target population

The intended population is people who can provide a behavioural response to the stimuli in ways instructed by intended users and is inclusive of all demographics.

Indications for use

No medical indication for use.

Medical condition(s)

There are no clinical conditions indicated for this device.

Contraindications

Over the ear/in-ear transducer placement is not possible if patient experiences otological discomfort, external ear abnormalities and acute external auditory canal trauma and pain, Users should consider cooperation requirements for pure tone and speech audiometry based on age or other conditions which prevent patients from responding to stimuli. Other objective methods to obtain audiometric data should be considered in these cases.



1.3 Product description

The Equinox Evo is a PC based 2-channel clinical audiometer (IEC 60645-1:2017, Type 1EHF Class A-E) operated in the software module AC440. The device offers a wide range of audiometric tests, such as Pediatric test, SISI, ABLB, Stenger, Weber, TEN test, Speech in noise, Langenbeck, IA-AMTAS, QuickSIN and MLD.

The system can be supplemented with the Touch Keyboard, for easy conduction of a selection of audiometric tests. The audiometric results enable the user to conduct a comprehensive evaluation of hearing capabilities and diagnose hearing disorders.

1.4 Standard and optional parts

Standard parts

- Affinity/Equinox Suite
- DD45 Audiometric headset¹
- Monitor Headset
- B81 Bone conductor¹
- APS3 Patient response button¹
- USB cable, 2 m
- Power supply
- Power cable
- Mouse pad
- Cleaning cloth

Standard parts may be replaced by an optional part dependent on the configuration ordered.

Optional parts

- Touch Keyboard
- Audiometer Keyboard
- IP30 insert earphones¹
- B71 Bone Conductor¹
- IP30 insert phone – single sided¹
- DD65 v2 audiometric headset¹
- DD450 High frequency headset¹
- SP90a Loudspeaker with Power supply UES60LCP2-240250SPA
- Splitter cable for patient response
- Speech microphone
- Ambient noise microphone
- Accessory bracket
- Table mount bracket
- Wall mount bracket
- OtoAccess® database

¹ Applied part according to IEC 60601-1



1.5 Warnings and precautions

Throughout this manual, the following definitions of warning, caution and notice are used:



WARNING

The **WARNING** label identifies conditions or practices that may present danger to the patient and/or user.



CAUTION

The **CAUTION** label identifies conditions or practices that could result in damage to the equipment.

NOTICE

NOTICE is used to address practices not related to personal injury.

For the US only: Federal law restricts this device to sale by or on the order of a licensed medical practitioner.

2 Unpacking and installation

2.1 Unpacking and inspection

Check box and contents for damage

When the instrument is received, please check the shipping box for rough handling and damage. If the box is damaged, it should be kept until the contents of the shipment have been checked mechanically and electrically. If the instrument is faulty, please contact your local distributor. Keep the shipping material for the carrier's inspection and insurance claim.

Keep carton for future shipment

The Equinox Evo comes in its own shipping carton, which is specially designed for the Equinox Evo. Please keep this carton. It will be needed if the instrument has to be returned for service. If service is required, please contact your local distributor.

Reporting Imperfections

Inspect before connection

Prior to connecting the product it should once more be inspected for damage. All of the cabinet and the accessories should be checked visually for imperfections and missing parts.

Immediately report any faults

Any missing part or malfunction should be reported immediately to the supplier of the device together with the invoice, serial number, and a detailed report of the problem. Enclosed you will find a "Return Report" where you can describe the problem.

Please use "Return Report"

Return Report will be of great help to us and is your best guarantee that the correction of the problem will be to your satisfaction.













Storage





If you need to store the Equinox Evo for a period, please ensure it is stored under the following conditions:

Temperature:	0 °C – 50 °C
Relative Humidity:	10 % - 95% Non-condensing

2.2 Markings

The following markings can be found on the device, accessories or packaging:

Symbol	Explanation
	Type B applied parts
	Follow instructions for use
	Consult electronic instruction for use
	WEEE (EU Directive) This symbol indicates that the product should not be discarded as unsorted waste but must be sent to separate collection for facilities for recovery and recycling.
	The CE-mark in combination with MD symbol indicates that Interacoustics A/S meets the requirements of the Medical Device Regulation (EU) 2017/745 Annex I. Approval of the quality system is made by TÜV – identification no. 0123.
	Medical device
	Date of manufacture
	Manufacturer
	Serial number
	Reference number
	Indicates a product is intended for one use, or for use on a single patient during a single procedure. Cross contamination risk.
	Keep dry
	Transport and storage temperature limit

Symbol	Explanation
	Transport and storage humidity limitations
<p data-bbox="236 405 336 421">ETL Classified</p>  <p data-bbox="252 472 320 495">Intertek</p> <p data-bbox="252 495 320 517">4005727</p> <p data-bbox="188 517 384 539">Conforms to AAMI ES60601-1</p> <p data-bbox="188 539 384 562">Certified to CSA C22.2 No. 60601-1</p>	ETL listing mark
	Logo
	Equipment includes radio frequency (RF) transmitters

2.3 Important safety instructions

Read these instructions carefully and completely before using the product.

2.3.1 Electrical system safety



WARNING

This equipment is intended to be connected to other equipment thus forming a Medical Electrical System. External equipment intended for connection to signal input, signal output or other connectors shall comply with IEC 60950-1 or IEC 62368-1 for IT equipment and the IEC 60601-series (Canada: CAN/CSA NO C22.2 60601-1) for medical electrical equipment. In addition, all such combinations shall comply with the safety requirements stated in IEC 60601-1, clause 16.

Any equipment not complying with the leakage current requirements in IEC 60601-1 shall be kept outside the patient environment i.e., at least 1.5 m from the patient support or shall be supplied via a separation transformer to reduce the leakage currents.

Any person who connects external equipment to signal input, signal output or other connectors has formed a Medical Electrical System and is therefore responsible for the system to comply with the requirements. If in doubt, contact qualified technician or your local representative.

When the equipment is connected to a PC, or similar equipment, beware of not touching the PC and patient simultaneously.

2.3.2 Electrical safety



WARNING

Do not modify this equipment without authorization of Interacoustics.

Do not disassemble or modify the product as this may impact on the safety and/or performance of the device. Refer servicing to qualified personnel.

Disconnect the power supply from the wall outlet to turn off the power of the device and/or to isolate the device from the supply mains.

The power plug shall be placed so it is easy to pull out the plug.

Do not use any additional multiple socket-outlet or extension cord.

Do not use the equipment if it is showing visible signs of damage.

The device is not protected against ingress of water or other liquids. If any spillage occurs, inspect the device carefully before use or return for service.

No part of the equipment can be serviced or maintained while in use with the patient.

To avoid the risk of electric shock, this equipment must only be connected to a supply mains with protective earth.

Disconnect power source before cleaning or repairing the device.

Use only the power supply specified by Interacoustics.

Replacement of batteries by inadequately trained personnel could result in a hazardous situation.

2.3.3 Explosion hazards



WARNING

Do not use the device in presence of flammable gaseous mixtures or in an oxygen-rich environment.

2.3.4 Electromagnetic compatibility (EMC)



WARNING

Use of this equipment adjacent to or stacked with other equipment should be avoided because it could result in improper operation. If such use is necessary, this equipment and the other equipment should be observed to verify that they are operating normally.

Use of accessories, transducers, and cables other than specified, except for transducers and cables specified by Interacoustics, could result in increased electromagnetic emissions or decreased electromagnetic immunity of the equipment and result in improper operation.

Refer to section 6.4 for a list of accessories, transducers and cables that fulfil the requirements.

Portable RF communications equipment (including peripherals such as antenna cables or external antennas) should be used no closer than 30 cm (12 inches) to any part of the Equinox Evo including cables specified by Interacoustics. Otherwise, degradation of the performance of this equipment could result.

2.3.5 Cautions – General



CAUTION

Do not operate the device if it is not functioning properly or defective. The device should be shipped for repair.

Do not drop or in any other way cause undue impact to the device. If any part of the device is damaged, return it to the manufacturer for repair and/or calibration.

This product and its components will perform reliably only when operated and maintained in accordance with the instructions contained in this manual, accompanying labels, and/or inserts.

Make sure all connections to external accessories are secured properly. Parts which may be broken or missing or are visibly worn, distorted, or contaminated should be replaced immediately with clean, genuine replacement parts manufactured by or available from Interacoustics.

Connect only accessories and products provided by Interacoustics to the device. Only accessories and products stated by Interacoustics to be compatible are allowed to be connected to the device.

Product labelled for 'single use' are intended for a single patient during a single procedure, and there is a risk of contamination if the product is re-used. Single use products are not intended to be reprocessed.

Use only accessories calibrated with the specific device. If accessories are exchanged, a re-calibration is necessary before use.

2.3.6 Environmental factors



CAUTION

Storage outside conditions as specified in Section 2.1 may cause permanent damage to the device and its accessories.

Do not place the device next to a heat source of any kind and allow sufficient space around it to ensure proper ventilation.

2.3.7 NOTICE

Interacoustics will make available on request circuit diagrams, component part lists, descriptions, calibration instructions, or other information that will assist authorized service personnel to repair those parts of this instrument that are designated by Interacoustics as repairable by service personnel.

Take appropriate precautions such as antivirus and firewalls to protect the PC environment.

Use the external power supply instead of connection to PC for optimal charging the Touch Keyboard.

Connecting the device to a PC implies connecting the device to an IT-network. The connection to an IT-network may result in previously unidentified risks to patients, operators or third parties. The risks must be identified, analysed, evaluated and controlled by the user or users' organisation.

Changes to the IT-network could introduce new risks that require additional analysis. Changes includes:

- changes in network configuration
- connection of additional items
- disconnection of items
- update of equipment
- upgrade of equipment.

Using discontinued operating systems will increase the risk for viruses and malware, which may result in breakdowns, data loss and data theft and misuse.

Some Interacoustics A/S products may work with unsupported operating systems however, Interacoustics recommends you to always use Microsoft supported operating systems that are kept fully security updated. Interacoustics cannot be held liable for your data or data loss caused by using unsupported/discontinued operating systems.

Electric and electronic waste may contain hazardous substances and therefore must be collected separately. Such products will be marked with the crossed-out wheeled bin symbol. The cooperation of the user is important to ensure a high level of reuse and recycling of electric and electronic waste. Failing to recycle such waste products in an appropriate way may endanger the environment and consequently the health of human beings.

Outside the European Union, local regulations should be followed when disposing of the device after end of life.

Any serious incident that has occurred in relation to the device should be reported to Interacoustics and to the competent authority of the Member State in which the user and/or patient is established.

2.4 Malfunction



In the event of a product malfunction, it is important to protect patients, users, and other persons against harm. Therefore, if the product has caused, or potentially could cause such harm, it must be quarantined immediately.

Both harmful and harmless malfunctions, related to the product itself or to its use, must immediately be reported to the distributor where the product was acquired. Please remember to include as many details as possible e.g., the type of harm, serial number of the product, software version, connected accessories and any other relevant information.

2.5 Disposal of the product

Interacoustics is committed to ensuring that our products are safely disposed of when they are no longer usable. The cooperation of the user is important to ensure this. Interacoustics therefore expects that local sorting and waste regulations for disposal of electric and electronic equipment are followed, and that the device is not discarded together with unsorted waste.

In case the distributor of the product offers a take-back scheme, this should be used to ensure correct disposal of the product.

2.6 Connection panel dictionary

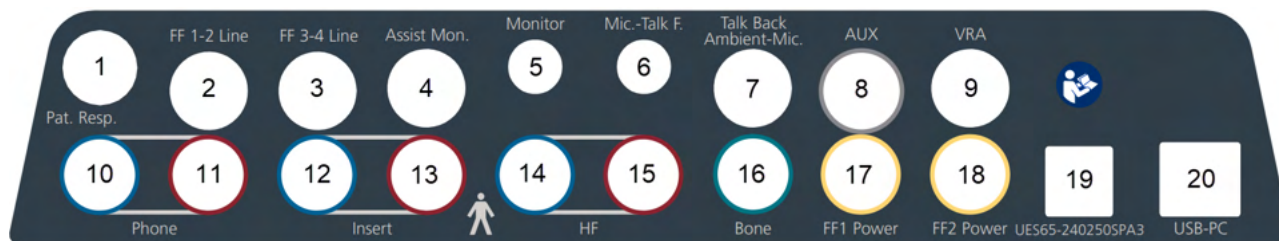

Position:	Text:	Socket function:
1	Pat. Resp.	Patient response button
2	FF 1-2 Line	Line output to free-field loudspeaker
3	FF 3-4 Line	Line output to free-field loudspeaker
4	Assist Mon.	Assistant monitor
5	Monitor	Monitor headset
6	Mic.-Talk F.	Talk forward microphone
7	Talk Back Ambient-Mic.	Talk back microphone or ambient noise microphone or automatic free field verification microphone
8	AUX	Line in from external sound source
9	VRA	Visual reinforcement audiometry system, analogue
10	Phone left	Left headphone or insert masker
11	Phone right	Right headphone
12	Insert left	Insert phone left or insert masker
13	Insert right	Insert phone right
14	HF left	High-frequency headphone left or insert masker
15	HF right	High-frequency headphone right
16	Bone	Bone conductor
17	FF1 Power	Power out to free-field loudspeaker
18	FF2 Power	Power out to free-field loudspeaker
19	UES65-240250SPA3	External power supply
20	USB-PC	USB connection to PC

2.6.1 Insert masker

Insert masker is designed to be used in any of the left transducer sockets (Phone, Insert and HF). The system automatically assigns a socket for the insert masker based on the calibration settings. The socket is assigned based on a priority. First priority is Phone left, second is Insert left and third is HF left. This means that if any of the left transducer sockets are not assigned to any transducer, Insert masker will be assigned to a socket based on the priority.

If a system already is calibrated for a phone, insert and HF transducer, Insert masker will not be available.

2.6.2 Talk Back/Ambient-Mic.

When using the dedicated microphone from Interacoustics, the Talk Back/Ambient-Mic will socket will work as both a Talk Back microphone as well as an Ambient noise microphone.

If any other microphone is used then this socket will only work as a Talk Back microphone.

2.7 Equinox Evo Indicators

The Equinox Evo hardware has an LED light indicator which changes status during different operations of the Equinox Suite and hardware. These different colors and their statuses are listed and shown below.

The LED light is visible from both the front and the top of the Equinox Evo.

GREEN: Ready

LIGHT BLUE: The Equinox Evo is not correctly connected to the Equinox Suite.

A dimmed light indicates that the Equinox Evo has entered power saving mode. This can happen in any of the colors mentioned above.

2.8 Software installation

To know before you start the Installation

You must have administrative rights to the computer on which you are installing the Equinox Suite.

NOTICE

Interacoustics will not make any guarantee to the functionality of the system if any other software is installed, with exception of the Interacoustics measurement (AC440) modules and OtoAccess® or Noah4 compatible Office Systems or later releases.

What you will need:

- Equinox Suite Installation USB Drive
- USB Cable
- Equinox Evo Hardware

Supported Noah Office Systems

We are compatible with all Noah-integrated office systems which are running on Noah and Noah engine.

To use the software in conjunction with a database, make sure the database is installed prior to the Equinox Suite installation. Follow the manufacturer's installation instructions provided to install the relevant database.

NOTICE: As a part of data protection, ensure to be compliant to all the following points:

1. Use Microsoft supported operating systems
2. Ensure operating systems are security patched
3. Enable database encryption
4. Use individual user accounts and passwords
5. Secure physical and network access to computers with local data storage
6. Use updated antivirus and firewall and anti-malware software
7. Implement appropriate backup policy
8. Implement appropriate log retention policy
9. Ensure to change any default administration passwords

2.8.1 Software installation on Windows®11 and Windows®10

Insert the installation USB drive and follow the steps below to install the Equinox Suite software. To find the installation file; click "Start", then go to "My Computer" and double click the USB drive to view the contents of the installation USB. Double click the "setup.exe" file to initiate the installation.

Wait for the dialog shown below to appear, you must accept the license terms and conditions ahead of installing. On checking the box to accept this, the Install button will become available, click "Install" to begin the installation.

Note: There are also options to include the installation of Interacoustics Universe and Equinox Evo documentation, including Instructions for use, within this step. They are by default checked. Uncheck these boxes if you do not wish installation. You can disable this if you wish.

Note: Images are examples and may look different depending on the version to be installed.

Make sure you are choosing Equinox Evo when selecting the hardware in this step.

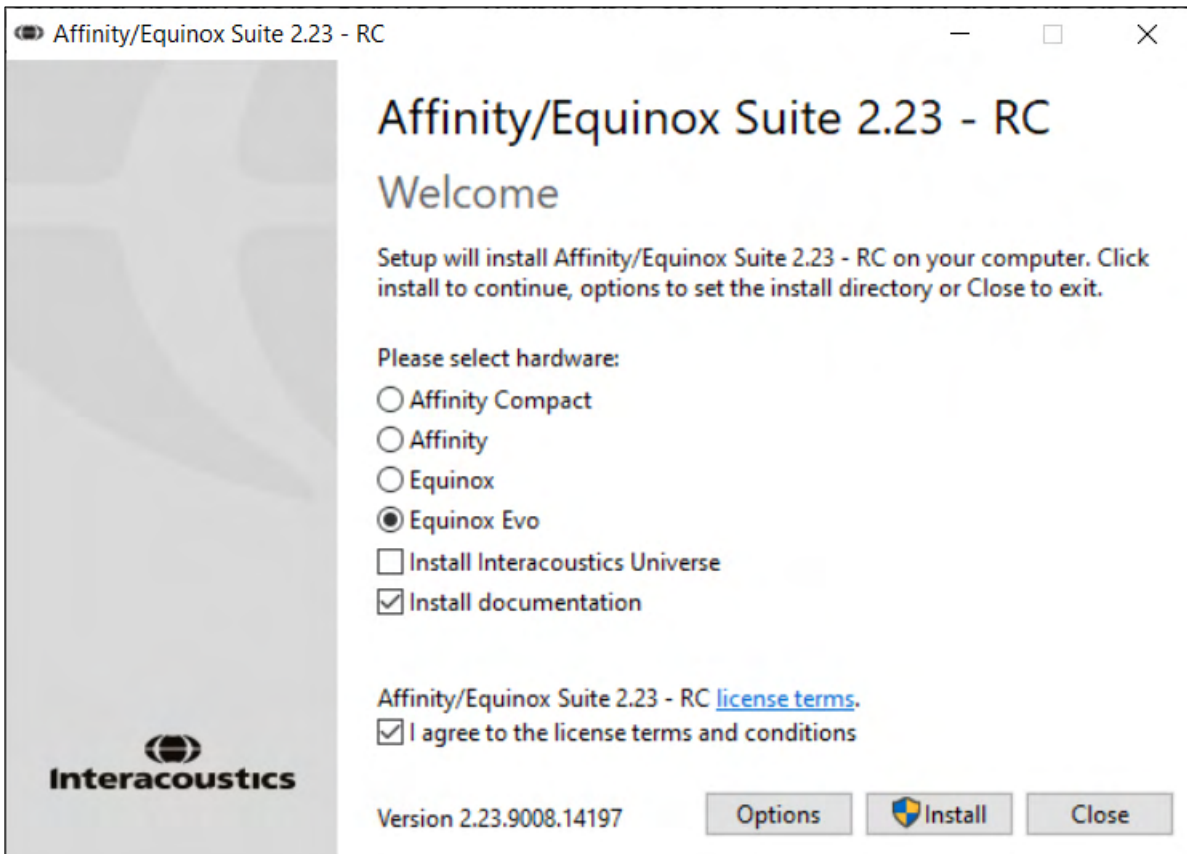

Should you wish to install the software to a different location than the default then please click on 'Options' ahead of 'Install'

User Account Control may ask if you want to allow the program to make changes to your computer. Click Yes if this happens.

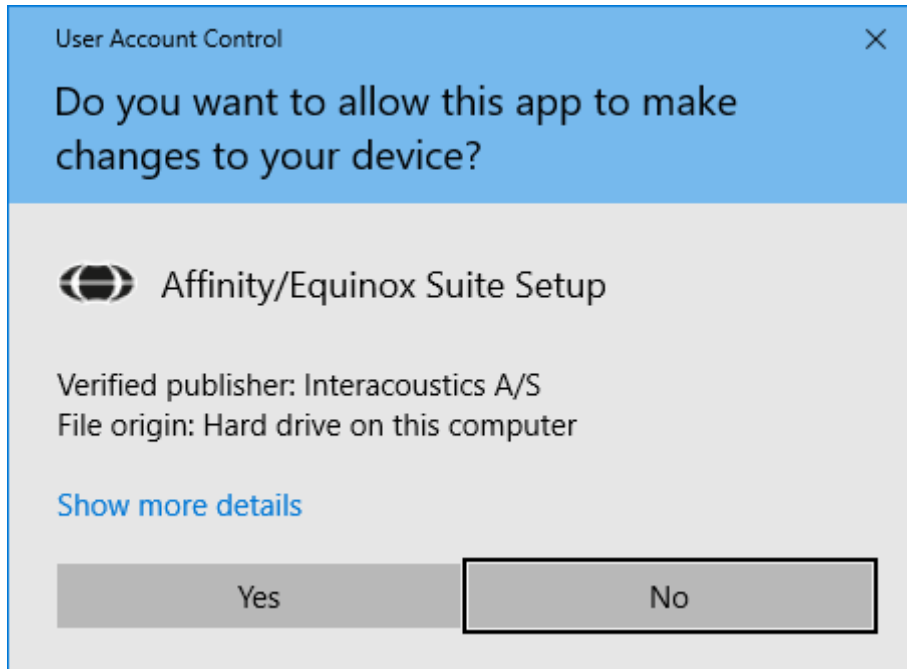

The installer will now copy all the necessary files to the PC. This process may take several minutes.

When the installation is complete, the dialog box below is shown.

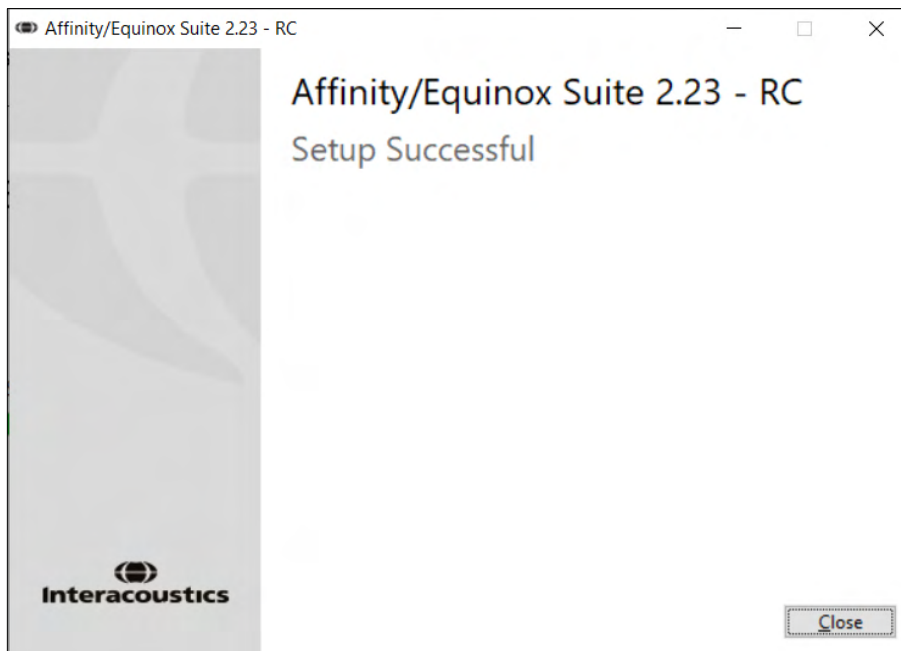

Click "Close" to finish the installation. The Equinox Suite is now installed.

2.9 Driver installation

Now that the Equinox Suite software is installed, you must install the driver for the hardware.

1. Connect the Equinox Evo hardware to the PC via the USB connection.
2. The system will now automatically detect the hardware and display a pop-up on the bottom right of the task bar. This indicates that the driver is installed, and the hardware is ready for use.

2.10 Use with databases

2.10.1 Noah 4

If you are using HIMSA's Noah 4, the Equinox Evo software will install itself automatically in the menu bar on the start page, along with all the other software modules.

2.10.2 OtoAccess®

For further instructions about working with OtoAccess®, please see the OtoAccess® operation manual.

2.11 Standalone version

If you do not have Noah on your computer, you can directly launch the Equinox Suite as a stand-alone module. However, you will only be able to save your recordings locally when using this way of working.

2.12 How to configure an alternative data recovery location

The Equinox Suite has a backup location for data to be written in the case that the software is accidentally terminated or the system crashes. The following locations are the default storage folder for recovery or standalone databases: C:\ProgramData\Interacoustics\Affinity Suite\

Note: This feature can be used to change the recovery location when you are working through a database as well as the standalone save location.

1. Go to C:\Program Files (x86)\Interacoustics\Affinity Suite
2. In this folder find and launch the executable program titled FolderSetupAffinity.exe
3. Following pop up will appear

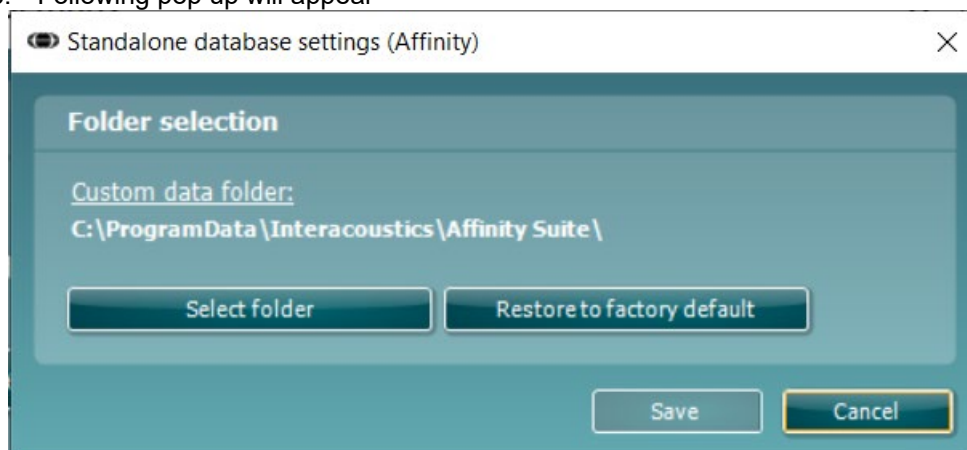

4. Using this tool, you can specify the location you wish to store the standalone database or the recovery data by clicking on the 'Select Folder' button and specifying the desired location.
5. Should you wish to revert the data location to the default then simply click on the 'Restore factory default' button.

2.13 Licenses

When you receive the product, it already contains the licenses to access the ordered software modules. If you would like to add additional modules, please contact your dealer.

2.14 About Equinox Suite

Should you go to **Menu > Help > About** then you will see the below window. This is the area of the software where you can manage license keys and check your Suite, Firmware and Build Versions.

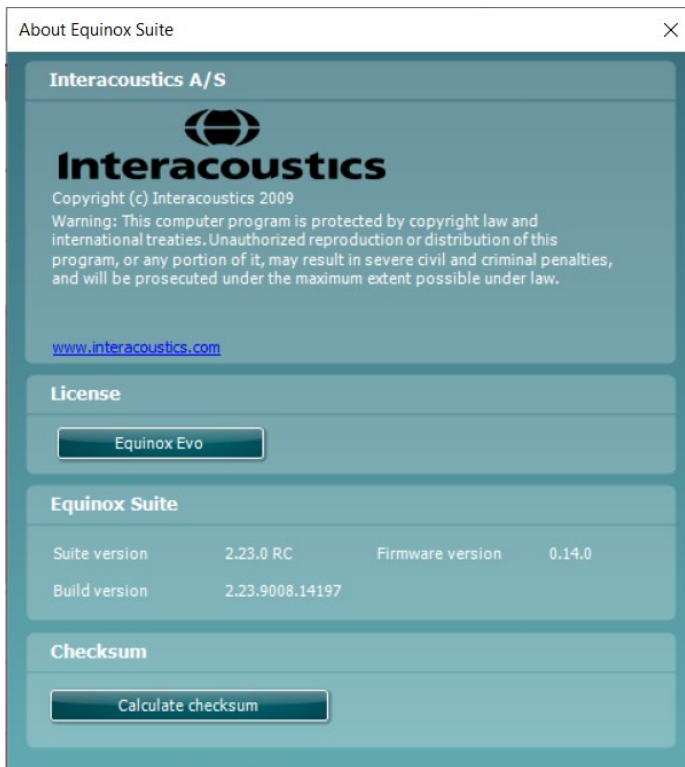

Also, in this window you will find the Checksum section which is a feature designed to help you identify the integrity of the software. It works by checking the file and folder content of your software version. This is using an SHA-256 algorithm.

On opening the checksum, you will see a string of characters and numbers, you can copy this by double clicking on it.

3 Operating instructions

The equipment should be placed so the power supply cable can be disconnected from the equipment with ease.

The instrument must warm up for at least 3 minutes in room temperature before use.

To minimize environmental impact, disconnect the device from mains power to completely turn off the device after use.

When operating the instrument, please observe the following general precautions:



1. The intended operators of the device are ENT doctors, Audiologists, and other professionals with similar knowledge. Using the instrument without adequate knowledge may lead to erroneous results and may endanger the patients hearing.
2. The Equinox Evo should be operated in a quiet environment, so that measurements are not influenced by external acoustic noises. This may be determined by an appropriately skilled person trained in acoustics. ISO 8253-1 section 11 defines guidelines for permissible ambient noise for audiometric hearing testing.
3. Only recorded speech material with a stated relationship with the accompanying calibration signal should be used. In the calibration of the instrument, it is assumed that the accompanying calibration signal level is equal to the average level for the speech material. If this is not the case, the calibration of the sound pressure levels will be invalid and the instrument needs recalibration.
4. The foam ear tips supplied with the optional IP30 transducers shall be replaced after each client tested. Foam ear tips are for single use.
5. Never insert, or in any way use, the insert headset without a new and non-defective ear tip. Always make sure that the foam or ear tip is mounted correctly.
6. Use only sound stimulation intensities that will be acceptable for the patient.
7. The transducers (headphones, bone conductor, etc.) supplied with the instrument are calibrated to this instrument - exchange of transducers requires a new calibration
8. Parts which are in direct contact with the patient (e.g. earphone cushions) shall be cleaned between patients.
9. Use only speech input that is adjusted to 0VU.
10. It is equally important that any free field installation is calibrated at the site where it is used and under conditions that reflect normal operation.

3.1 Using the tone screen

The following section describes the elements of the tone screen.

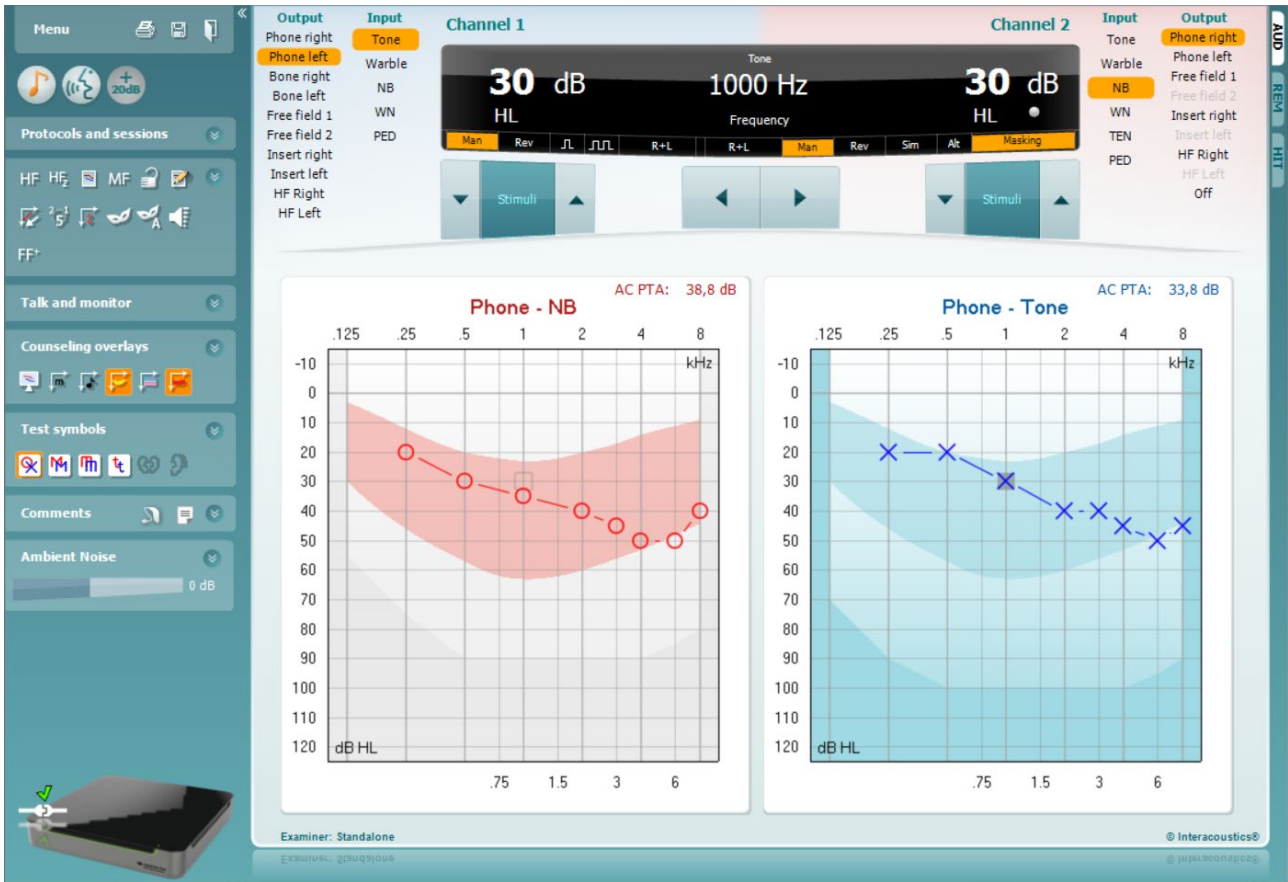

Menu provides access to Print, Edit, View, Tests, Setup, and Help



Print allows for printing the session's acquired data.



Save & New Session saves the current session in Noah or OtoAccess® and opens a new one.



Save & Exit saves the current session in Noah or OtoAccess® and exits the Suite.



Collapse the left side panel.



Go to Tone Audiometry activates the tone screen when in another test.



Go to Speech Audiometry activates the speech screen when in another test.



Extended Range +20 dB extends the testing range and can be activated when the testing dial setting gets within 50 dB of the maximum level of the transducer.

Note that the extended range button will flash when it needs activation for reaching higher intensities.

To switch on the extended range automatically, select the **Switch extended range on automatically** by going to the setup menu.

Fold an area so that it only shows the label or the buttons of that area.



Unfold an area so that all buttons and labels are visible

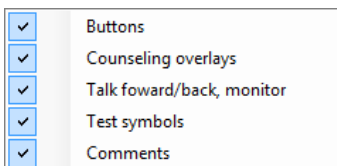

Show/hide areas can be found by right mouse clicking on one of the areas. The visibility of the different areas as well as the space that they take on the screen is locally saved to the examiner.



List of Defined Protocols allows for selecting a test protocol for the current test session. Right mouse click on a protocol allows the current examiner to set or deselect a default startup protocol.

Please refer to the Equinox Evo “Additional Information” document for more information on protocols and protocol setup.



Temporary Setup allows for making temporary changes to the selected protocol. The changes will be valid for the current session only. After making the changes and returning to the main screen, the name of the protocol will be followed by an asterisk (*).

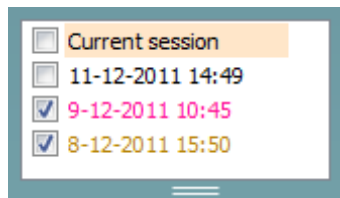

List of historical sessions accesses historical sessions for comparison purposes. The audiogram of the selected session, indicated by the orange background, is shown in colours as defined by the used symbol set. All other audiograms that are selected by check marks show on screen in the colours as indicated by the text colour of the date and time stamp. Note that this listing can be resized by dragging the double lines up or down.



Go to Current Session brings you back to the current session.

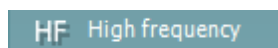

High Frequency² shows frequencies on the audiogram (up to 20 kHz for the Equinox Evo). However, you will only be able to test in the frequency range the selected headset is calibrated for.

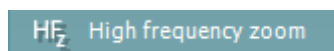

High Frequency Zoom activates high frequency testing and zooms in on the high frequency range.

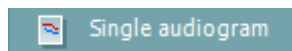

Single audiogram toggles between viewing the information of both ears in a single graph and two separate graphs.



Multi frequencies³ activates testing with frequencies in between the standard audiogram points. The frequency resolution can be adjusted in the AC440 setup.

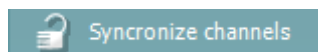

Synchronize channels locks the two channels together. This function may be used to perform synchronous masking.

² HF requires an additional license for the AC440. If not purchased, the button is grayed out.

³ MF requires additional license for the AC440. If not purchased, the button is grayed out.



Edit Mode button activates the editing function. Left clicking on the graph will add/move a point to the position of the cursor. If right clicking on a specific stored point a context menu appears offering you the following options:

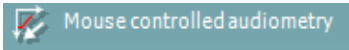
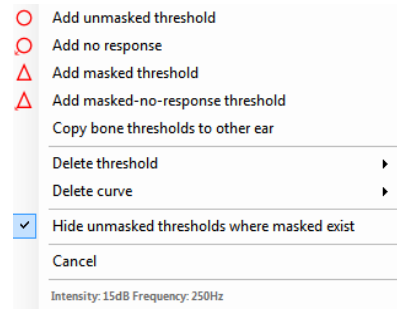

Mouse controlled audiometry enables you to do the audiometry using the mouse only. Left click on the mouse to present the stimulus. Right click on the mouse to store the result.



The **dB step size** button indicates to which dB step size the system is currently set. It rotates between 1 dB, 2 dB and 5 dB step sizes.

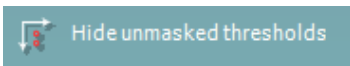

The **hide unmasked threshold** will hide those unmasked thresholds where masked thresholds exist.

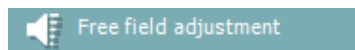

The **Free field adjustment** tool allows you to perform a referencing procedure for Free field Audiometry and Speech Audiometry measurements.



Free Field+ lets you activate up to 4 speakers at a time, when your device is calibrated to it.



Toggle Masking Help will activate or deactivate the Masking Help feature.

For more information on Masking Help, please refer to the Equinox Evo “Additional Information” or the “Masking Help Quick Guide” documents.

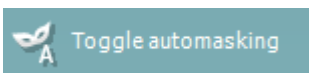

Toggle Automasking will activate or deactivate the Automasking feature.

For more information on Automasking, please refer to the Equinox Evo “Additional Information” or the “Masking Help Quick Guide” documents



Talk Forward activates the Talk Forward microphone. The arrow keys can be used to set the talk forward level through the currently selected transducers. The level will be accurate when VU meter indicates to be at zero dB.



Selecting the **Monitor Ch1** and/or **Ch2** check boxes allow you to monitor one or both channels through an external loudspeaker/headset connected to the monitor input. The monitor intensity is adjusted by the arrow keys.



The **Talk back** check box enables you to listen to the patient. Note that you need to be equipped with a microphone connected to the talk back input and an external loudspeaker/headset connected to the monitor input.

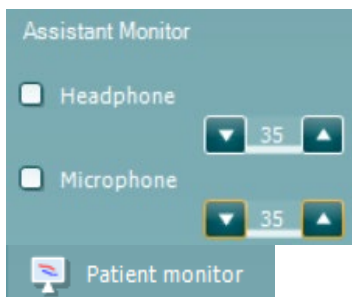

The **Assistant Monitor** section is for communication between the operator and an assistant. Checking the **Headphone** box will allow the assistant to hear the operator. Checking the **Microphone** box will allow the assistant to talk to the operator.

When the operator activates Talk back while **Headphone** is enabled, the assistant can hear the patient as well.

The **Patient monitor** opens an always-on-top window with the tone audiograms and all its counselling overlays shown. The size and position of the patient monitor gets saved for each examiner individually.



The **Phonemes** counselling overlay shows phonemes as it is set up in the protocol that is currently in use.

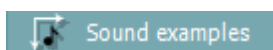

The **Sound examples** counselling overlay shows pictures (png-files) as they are set up in the protocol that is currently in use.



The **Speech banana** counselling overlay shows the speech area as it is set up in the protocol that is currently in use.

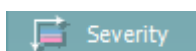

The **Severity** counselling overlay shows the degrees of hearing loss as it is set up in the protocol that is currently in use.



The **Max. testable values** show the area beyond the maximum intensity the system allows. This reflects the transducer calibration and depends on the extended range being activated.

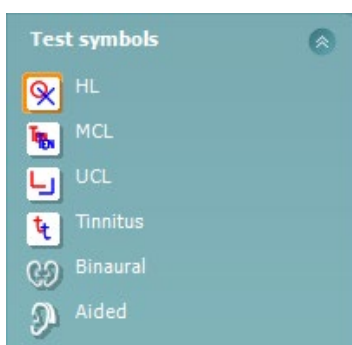

Selecting **HL**, **MCL**, **UCL**, **Tinnitus**, **Binaural** or **Aided** sets the symbol types that are currently in use by the audiogram. **HL** stands for hearing level, **MCL** stands for most comfortable level and **UCL** stands for uncomfortable level. Note that these buttons show the unmasked right and left symbols of the currently selected symbol set.

Binaural and **Aided** function allows for indicating if the test is performed binaurally or while the patient is wearing hearing aids. Typically, these icons are only available when the system is playing stimuli via freefield speaker.

Each type of measurement is saved as a separate curve.

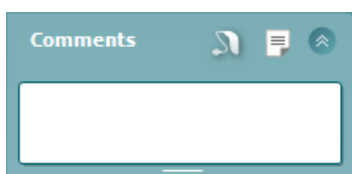

In the **Comments** section you can type comments related to any audiometric test. The used space by the comments area can be set by

dragging the double line with your mouse. Pressing the  button opens a separate window for adding notes to the current session. The report editor and comment box contain the same text. In case the formatting of the text is important, this can only be set within the report editor.

On pressing the  button you will see a menu which allows you to specify the hearing aid style on each ear. This is just for note taking when performing aided measurements on your patient.

After saving the session, comment changes can only be made within the same day until the date changes (at midnight). **Note:** these timeframes are limited by HIMSA and the Noah software and not by Interacoustics.

Output	Input
Phone right	Tone
Phone left	Warble
Bone right	NB
Bone left	WN
Free field 1	
Free field 2	
Insert right	
Insert left	

The **Output** list for channel 1 provides the option to test through headphones, bone conductor, free field speakers or insert phones. Note that the system only shows the calibrated transducers.

The **Input** list for channel 1 provides the option to select pure tone, warble tone, narrow band noise (NB), white noise (WN) and Pediatric noise⁴ (PED).

Note that the background shading is according to the side that is selected, red for right and blue for left.

Input	Output
Tone	Phone right
Warble	Phone left
NB	Free field 1
WN	HF Right
TEN	HF Left
PED	Off

The **Output** list for channel 2 provides the option to test through headphones, free field speakers, insert phones or insert masking phone. Note that the system only shows the calibrated transducers.

The **Input** list for channel 2 provides the option to select pure tone, warble tone, narrow band noise (NB), white noise (WN) and TEN noise⁵.

Note that the background shading is according to the side that is selected, red for right, blue for left, and white when off.



Pulsation allows for single and continuous pulsating presentation. The duration of the stimulus can be adjusted in the AC440 setup.



Sim/Alt allows toggling between **Simultaneous** and **Alternate** presentation. Ch1 and Ch2 will present the stimulus simultaneously when Sim is selected. When Alt is selected, the stimulus will alternate between Ch1 and Ch2.



Masking indicates if channel 2 is currently in use as a masking channel and in that way makes sure masking symbols are used in the audiogram. For example, in paediatric testing through free field speakers, channel 2 can be set as a second testing channel. Note that a separate store function for channel 2 is available when channel 2 is not used for masking.

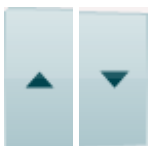

dB HL Increase and **Decrease** buttons allows for increasing and decreasing the intensities of channel 1 and 2.

The arrow keys on the PC keyboard can be used for in-/decreasing channel 1 intensities.

PgUp and PgDn on the PC keyboard can be used for in-/decreasing channel 2 intensities.



Stimuli or **attenuator** buttons will light up when the mouse goes over and indicates the active presentation of a stimulus.

A right mouse click in the Stimuli area will store a no response threshold. A left mouse click in the Stimuli area will store the threshold at the current position.

Channel 1 stimulation can also be obtained by pressing the space bar or left Ctrl key on the PC keyboard.

Channel 2 stimulation can also be obtained by pressing the right Ctrl key on the PC keyboard.

⁴ Pediatric noise requires an additional license for the AC440.

⁵ TENs test requires an additional license for the AC440. If not purchased, the stimulus is grayed out.

Mouse movements in the Stimuli area for both channel 1 and channel 2 can be ignored depending on the setup.



Frequency and Intensity display area shows what is currently presented. To the left the dB HL value for channel 1 is shown and to the right for channel 2. In the centre the frequency is displayed.

Notice that the dB dial setting will flash when trying to go louder than the maximum available intensity.

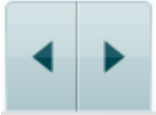

Frequency increase/decrease increases and decreases the frequency respectively. This can also be obtained using the left and right arrow keys on the PC keyboard.

Storing thresholds for channel 1 is done by pressing **S** or by a left mouse click in the Stimuli button of channel 1. Storing a no response threshold can be done by pressing **N** or by a right mouse click on the Stimuli button of channel 1.

Storing thresholds for channel 2 is available when channel 2 is not the masking channel. It is done by pressing **<Shift> S** or by a left mouse click on the Stimuli button of channel 2. Storing a no response threshold can be done by pressing **<Shift> N** or by a right mouse click in the attenuator of channel 2.



The hardware indication picture indicates whether the hardware is connected. **Simulation mode** is indicated when operating the software without hardware.

When opening the Suite, the system will search for the hardware. If it does not detect the hardware, then the system will automatically continue in simulation mode and the Simulation icon (left) will show in place of the connected hardware indication picture.

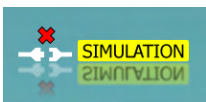

The **Examiner** indicates the current clinician who is testing the patient. The examiner is saved with a session and can be printed with the results.

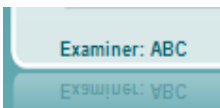

For each examiner is logged how the suite is set up with regards to the use of space in the screen. The examiner will find that the suite starts up looking the same as the last time they used the software. An examiner can also select which protocol must be selected at start up (by right mouse click on the protocol selection list).

3.2 Using the speech screen

The following section describes the elements of the speech screen in addition to the tone screen:



Input levels sliders allow for adjusting the input level to 0 VU for the selected input. This ensures that correct calibration is obtained for Mic1, AUX1, and AUX2.

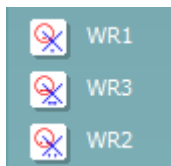

WR1, WR2 and WR3 (Word Recognition) allows selecting different speech list setups as defined by the selected protocol. The labels of these lists which go along with these buttons can also be customized in the protocol setup.

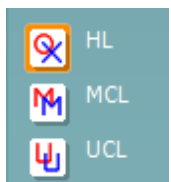

Selecting **HL, MCL and UCL** sets the symbol types that are currently in use by the audiogram. HL stands for hearing level, MCL stands for most comfortable level and UCL stands for uncomfortable level.

Each type of measurement is saved as a separate curve.

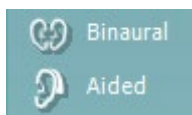

Binaural and Aided function allows for indicating if the test is performed binaurally or while the patient is wearing hearing aids.

Output	Input
Phone right	WN
Phone left	Mic 1
Bone right	AUX 1
Bone left	AUX 2
Free field 1	SN
Free field 2	Wavefile 1
Insert right	Wavefile 2
Insert left	

The **Output** list for channel 1 provides the option to test through the desired transducers. Note that the system only shows the calibrated transducers.

The **Input** list for channel 1 provides the option to select white noise (WN), speech noise (SN), Mic1, AUX1, AUX2 and wavefile.

Note that the background shading is according to the side that is selected, red for right and blue for left.

Input	Output
WN	Phone right
Mic 1	Phone left
AUX 1	Free field 1
AUX 2	Insert right
SN	Insert left
	Off

The **Output** list for channel 1 provides the option to test through the desired transducers. Note that the system only shows the calibrated transducers.

The **Input** list for channel 2 provides the option to select white noise (WN), speech noise (SN), Mic1, AUX1, AUX2 and wavefile.

Note that the background shading is according to the side that is selected, red for right, blue for left, and white when off.

Speech Scoring:

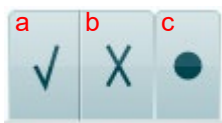

- Correct:** A mouse click on this button will store the word as correctly repeated. You can also click on the **Left** arrow key to store as correct*.
- Incorrect:** A mouse click on this button will store the word as incorrectly repeated. You can also click on the **Right** arrow key to store as incorrect*.

*When using the graph mode the correct/incorrect scoring is assigned by using the **Up** and **Down** arrow keys.

- Store:** A mouse click on this button will **store** the speech threshold in the speech graph. A point can also be stored by pressing **S**.

Phoneme scoring:



- Phoneme scoring:** If phoneme scoring is selected in the AC440 setup, mouse click on the corresponding number to indicate phoneme score. You can also click on the **Up** key to store as correct and **Down** key to store as incorrect.
- Store:** A mouse click on this button will store the speech threshold in the speech graph. A point can also be stored by pressing **S**.

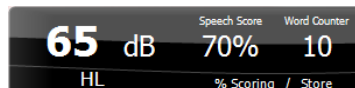

Frequency and Speech score display shows what is currently presented. On the left the dB value for channel 1 is shown and on the right side for channel 2.

In the centre of the current *Speech Score* in % and the *Word Counter* monitors the number of words presented during the test.

3.2.1 Speech audiometry in graph mode

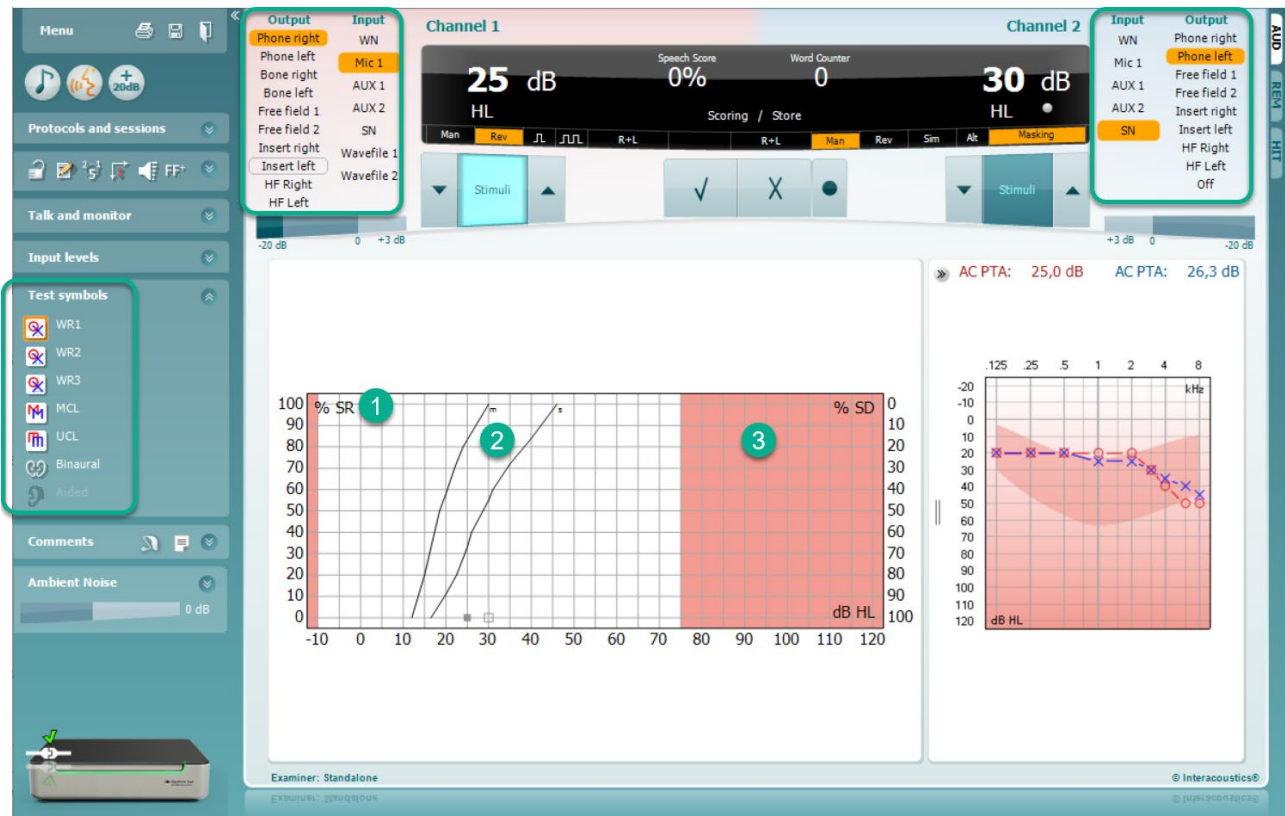

Graph mode presentation settings under “Test Symbols” and in the presentation options (Ch1 and Ch2) in the upper part of the screen shows where you can adjust the test parameters during the test.

1. **The graph:** The curves of the recorded speech graph will be displayed on your screen. The x-axis shows the intensity of the speech signal, and the y-axis shows the score in percent. The score is also displayed in the black display in the upper part of the screen, along with a word counter.
2. **The norm curves** illustrate norm values for **S** (Single syllabic) and **M** (Multi syllabic) speech material respectively. The curves can be edited according to individual preferences in the AC440 setup.
3. **The shaded area** illustrates the maximum intensity the system will allow. The *Extended Range +20 dB* button can be pressed to go higher. The maximal loudness is determined by the transducer calibration.

3.2.2 Speech audiometry in table mode

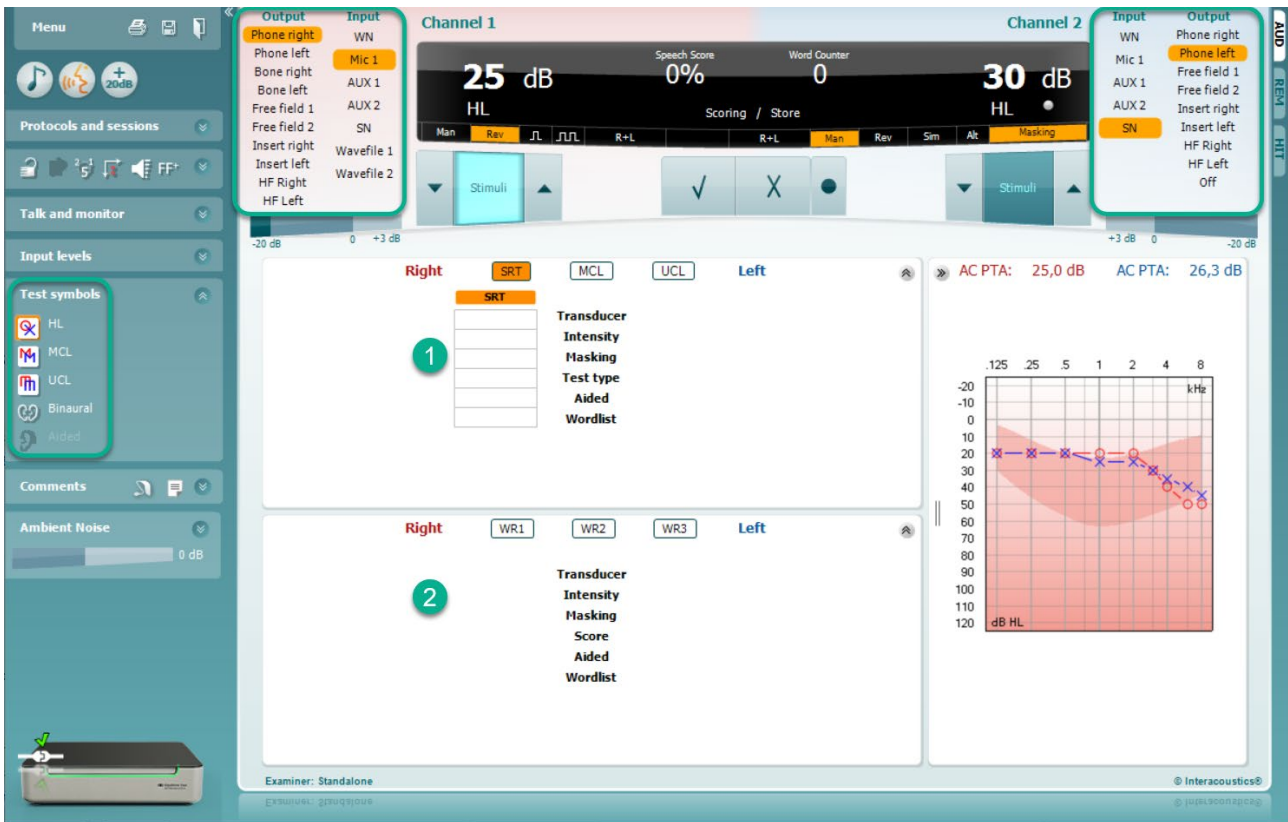

The Table Mode consists of two tables:

1. The **SRT** (Speech Reception Threshold) table: When the SRT test is active, it is indicated in orange. There are also options to conduct speech audiometry to find **MCL** (Most Comfortable Level) and **UCL** (Uncomfortable Loudness Level). These are also highlighted in orange when activated.
2. The **WR** (Word Recognition) table: When WR1, WR2, or WR3 is active the corresponding label will be orange.

The SRT table

The SRT table (Speech Reception Threshold table) allows for measuring multiple SRTs using different test parameters, e.g. *Transducer, Test Type, Intensity, Masking, and Aided*.

Upon changing *Transducer, Masking, and/or Aided* and re-testing, an additional SRT entry will appear in the SRT table. This allows for multiple SRT measurements to be shown in the SRT table. The same can be applied for when performing MCL (Most Comfortable Level) and UCL (Uncomfortable Loudness level) speech audiometry.

Please refer to the Equinox Evo Additional Information document for more information about SRT testing.

Right		SRT	MCL	UCL	Left	
SRT	SRT				SRT	SRT
Phone	Phone				Phone	Phone
30	10				10	30
15	15				15	15
HL	HL				HL	HL
	x				x	
Spondee A	Spondee B				Spondee A	Spondee B
		Transducer				
		Intensity				
		Masking				
		Test Type				
		Aided				
		Wordlist				

The WR Table

The word recognition (WR) table allows for measuring multiple WR scores using different parameters (e.g. *Transducer, Test Type, Intensity, Masking, and Aided*).

Upon changing *Transducer, Masking, and/or Aided* re-testing an additional WR entry will appear in the WR table. This allows for multiple WR measurements to be shown in the WR table.

Please refer to the Equinox Evo Additional Information document for more information about Word Recognition testing.

Right		WR1	WR2	WR3	Left	
WR1	WR1				WR1	WR2
Phone	FF1				Phone	FF2
55	55				55	30
85	95				90	100
	x					
NU-6 LIST 1A	NU-6 LIST 3A				NU-6 LIST 1A	Spondee A
		Transducer				
		Intensity				
		Masking				
		Score				
		Aided				
		Wordlist				

Binaural and Aided options

To perform binaural speech tests:

1. Click on either SRT or WR, to choose the test to be conducted binaurally
2. Ensure that the transducers are set up for binaural testing. For example, insert Right in channel 1 and insert Left in channel 2
3. Click on  Binaural
4. Proceed with the test; when stored, results will be stored as binaural results

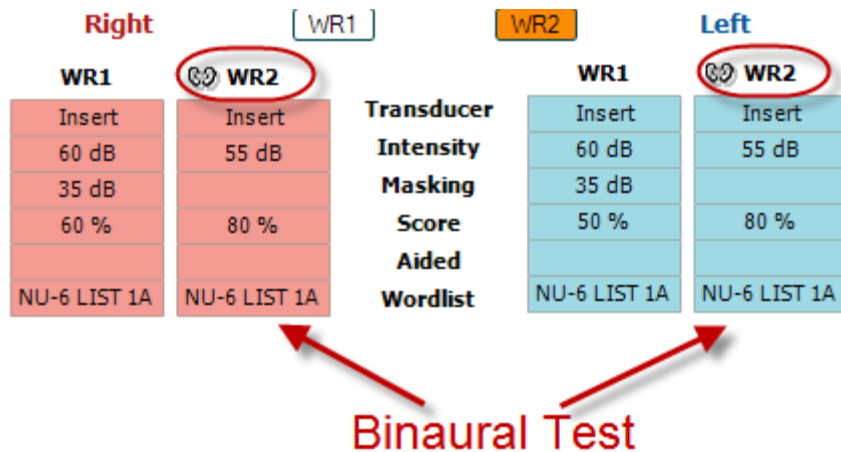

To perform an aided test:

1. Select the desired transducer. Typically, aided testing is done in the Free Field. However, in certain conditions, it could be possible to test deeply inserted CIC hearing instruments under headphones, which would show ear-specific results
2. Click on the Aided button
3. Click on the Binaural button if the test is done in the Free Field so that the results are stored for both ears at the same time
4. Proceed with test; results will then be stored as aided by showing an Aided icon

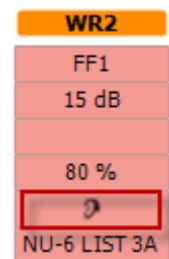

3.3 PC keyboard shortcuts manager

The PC Shortcut Manager allows the user to personalize PC shortcuts in the AC440 Module. To access the PC Shortcut Manager:

Go to AUD module | Menu | Setup | PC Shortcut Keys

To view the default shortcuts, click on the items in the left-hand column (Common 1, Common 2, Common 3, etc.)



To personalize a shortcut, click on the column in the middle and add the custom shortcut in the field on the right hand of the screen

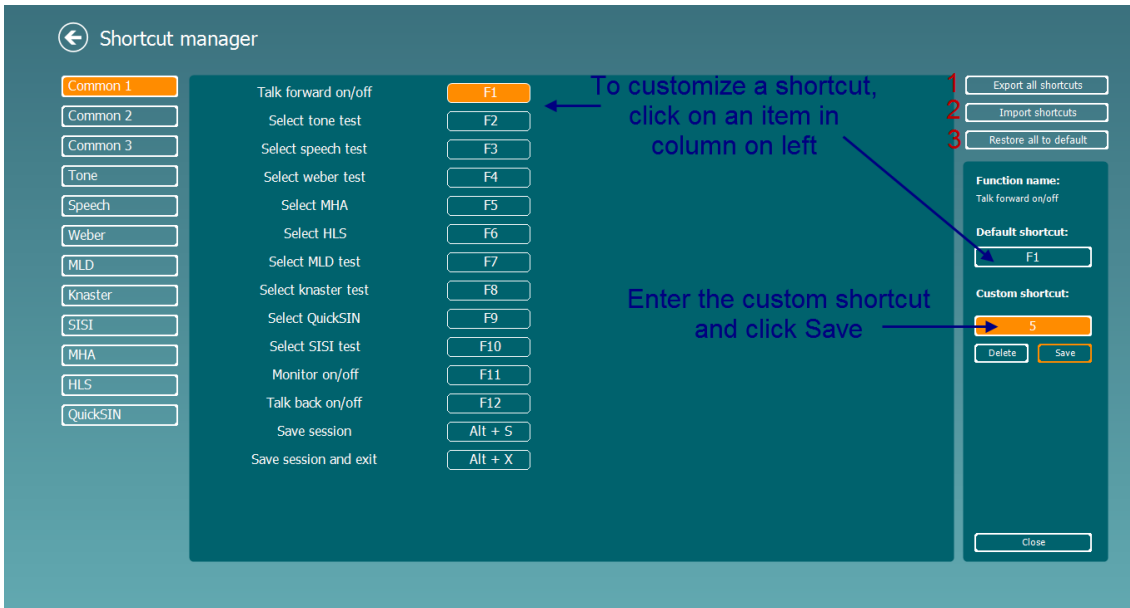

1. **Export all shortcuts:** Use this function to save custom shortcuts and transfer them to another computer.
2. **Import shortcuts:** Use this function to import shortcuts that have already been exported from another computer.
3. **Restore all defaults:** Use this function to restore the PC shortcuts to Factory Settings default.

3.4 Technical Specifications - AC440 software

Medical CE-mark:	The CE mark in combination with MD symbol indicates that Interacoustics A/S meets the requirements of the Medical Device Regulation (EU) 2017/745 Annex I Approval of the quality system is made by TÜV – identification no. 0123.
Audiometer standards:	IEC 60645-1:2017, Type 1EHF Class A-E ANSI S3.6-2018 (R2023), Type 1HF Class B
Transducers & calibration:	Calibration information and instructions are located in the Service manual. Check the accompanying Appendix for RETSPL levels for transducers
Air Conduction DD45 DD65 v2 DD450 IP30	ISO 389-1:2017, ANSI S3.6-2018 (R2023) Headband Static Force 4.5N ±0.5N PTB 1.61-4091606/18, AAU 2018 Headband Static Force 11.5N ±0.5N ISO 389-8:2004, ANSI S3.6-2018 (R2023) Headband Static Force 10N ±0.5N ISO 389-2:1994 ANSI S3.6-2018 (R2023)
Bone Conduction B71 B-81	Placement: Mastoid ISO 389-3:2016, ANSI S3.6-2018 (R2023) Headband Static Force 5.4N ±0.5N ISO 389-3:2016, ANSI S3.6-2018 (R2023) Headband Static Force 5.4N ±0.5N
Free Field	ISO 389-7:2019 ANSI S3.6-2018 (R2023)
High Frequency	ISO 389-5:2006, ANSI S3.6-2018 (R2023)
Effective masking	ISO 389-4:1994, ANSI S3.6-2018 (R2023)
Patient response switch:	Handheld push button
Patient communication:	Talk Forward and Talk Back
Monitor:	Output through external headset
Stimuli:	Pure tone, Warble tone, NB, SN, WN, TEN noise, PED noise, Wave files
Tone	125-20.000 Hz separated in two ranges 125-8.000 Hz and 8.000-20.000Hz. Resolution 1/2-1/24 octave
Warble tone	125-16.000 Hz separated in two ranges 125-8.000 Hz and 8.000-16.000Hz. 1-10 Hz sine +/- 5% modulation
PED noise	125-20.000 Hz separated in two ranges 125-8.000 Hz and 8.000-20.000Hz. Resolution 1/2-1/24 octave
Wave file	44.100 Hz sampling, 16 bits, 2 channels
Masking Narrow band noise: White noise: Speech noise.	Automatic selection of narrow band noise (or white noise) for tone presentation and speech noise for speech presentation. IEC 60645-1:2017, ANSI S3.6-2018 (R2023), 5/12 Octave filter with the same center frequency resolution as pure tone 80-20.000 Hz measured with constant bandwidth IEC 60645-1:2017, ANSI S3.6-2018 (R2023). 125-6.300 Hz falling 12dB/octave above 1 kHz +/-5 dB
Presentation	Manual or Reverse. Single or multiple pulses. pulse time adjustable from 200 mS-5000 mS in 50 mS steps. Simultaneous or alternating
Intensity	Check the accompanying Appendix for maximum output levels

Steps	Available Intensity Steps is 1, 2 or 5 dB
Accuracy	Sound pressure levels: ± 3 dB Vibration force levels: ± 4 dB
Extended range function	If not activated, the Air Conduction output will be limited to 20 dB below maximum output
Frequency	Range: 125 Hz to 8 kHz (Optional High Frequency: 8 kHz to 20 kHz) Accuracy: Better than ± 1 %
Distortion (THD)	Sound pressure levels: below 2.5 % Vibration force levels: below 5.5 %
Signal indicator (VU):	Time weighting: 350 mS Dynamic range: -20 dB to +3 dB Rectifier characteristics: RMS Selectable inputs are provided with an attenuator by which the level can be adjusted to the indicator reference position (0 dB)
Free field output level:	Compliant to IEC 60645-1:2017/ANSI S3.6-2018 (R2023) at a distance of 1 meter from speaker
Storing capability:	Tone audiogram: dB HL, MCL, UCL, Tinnitus. Speech Audiogram: WR1, WR2, WR3, MCL, UCL, Aided, Unaided, Binaural
Compatible software:	Noah 4, OtoAccess®

3.5 Using the print wizard

In the Print Wizard you have the option to create customized print templates which can be linked to individual protocols for quick printing. The Print Wizard can be reached in two ways.

- a. If you want to use a template for general use, or select an existing one for printing: Go to **Menu/File/Print Layout...** in any of the Equinox Suite AUD tab
- b. If you want to create a template or select an existing one to link to a specific protocol: Select the Module tab (AUD) relating to the specific protocol and select **Menu/Setup/AC440 setup**. Select the specific protocol from the drop-down menu and select **Print Setup** at the bottom of the window.

Now the **Print Wizard** window opens and shows the following information and functionalities:

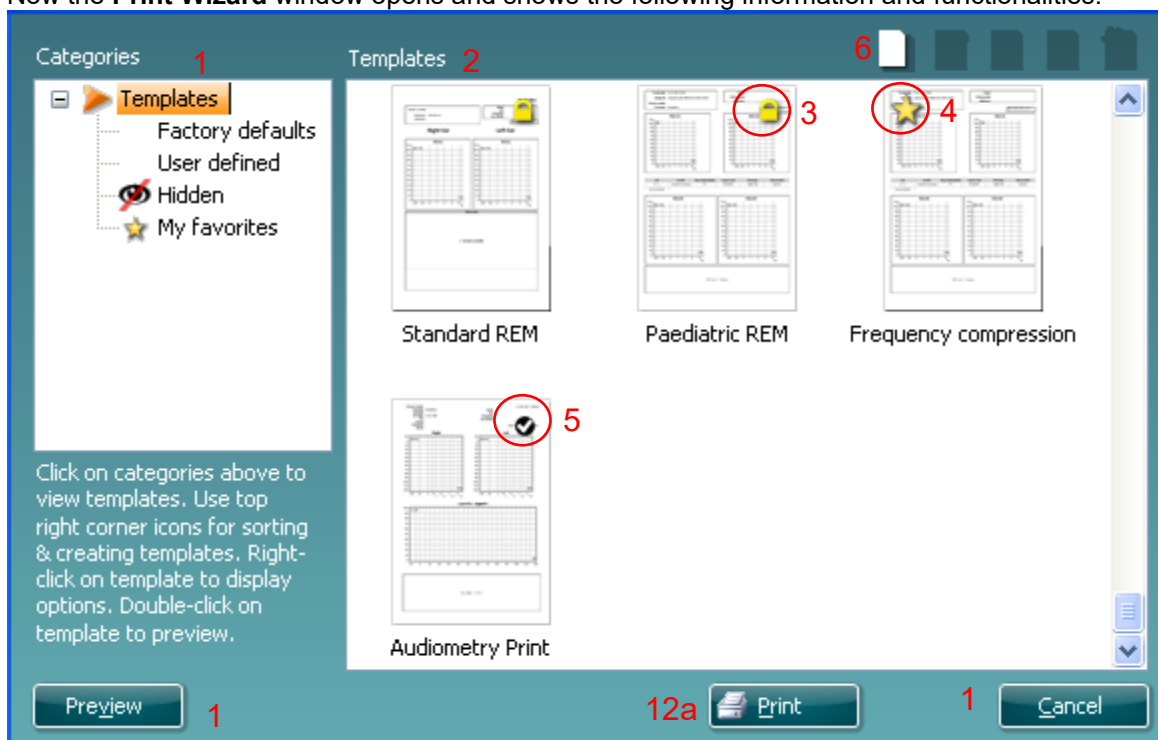

1. Underneath **Categories** you can select



- **Templates** to show all available templates
 - **Factory defaults** to show only standard templates
 - **User defined** to show only custom templates
 - **Hidden** to show hidden templates
 - **My favorites** to show only templates marked as a favorite
2. Available templates from the selected category are shown in the **Templates** viewing area.
 3. Factory default templates are recognized by the lock icon. They ensure that you always have a standard template and do not need to create a customized one. However, to edit these default templates, they need to be saved under a new name. **User defined**/created templates can be set to **Read-only** (showing the lock icon), by right clicking on the template and selecting **Read-only** from the drop-down list. **Read-only** status can also be removed from **User defined** templates by following the same steps.
 4. Templates added to **My favorites** are marked with a star. Adding templates to **My favorites** allows quick viewing of your most used templates.
 5. The template that is attached to the selected protocol when entering the print wizard via the **AC440** window is recognized by a checkmark.

- Press the **New Template** button to open a new empty template.
6. Select one of the existing templates and press the **Edit Template** button to modify the selected layout.
 7. Select one of the existing templates and press the **Delete Template** button to delete the selected template. You will be prompted to confirm that you want to delete the template.
 8. Select one of the existing templates and press the **Hide Template** button to hide the selected template. The template will now be visible only when **Hidden** is selected under **Categories**. To unhide the template, select **Hidden** under **Categories**, right click on the desired template and select **View/Show**.
 9. Select one of the existing templates and press the **My Favorites** button to mark the template as a favorite. The template can now be quickly found when **My Favorites** is selected under **Categories**. To remove a template marked with a star from My Favorites, select the template and press the **My Favorites** button.
 10. Select one of the templates and press the **Preview** button to print preview the template on screen.
 11. Depending how you reached the Print Wizard, you will have the option to press
 - a. **Print** for using the selected template for printing or press
 - b. **Select** for dedicating the selected template to the protocol from which you got into the Print Wizard.
 12. To leave the Print Wizard without selecting or changing a template press **Cancel**.

Right clicking on a specific template provides a drop-down menu offering an alternative method for performing the options as described above:

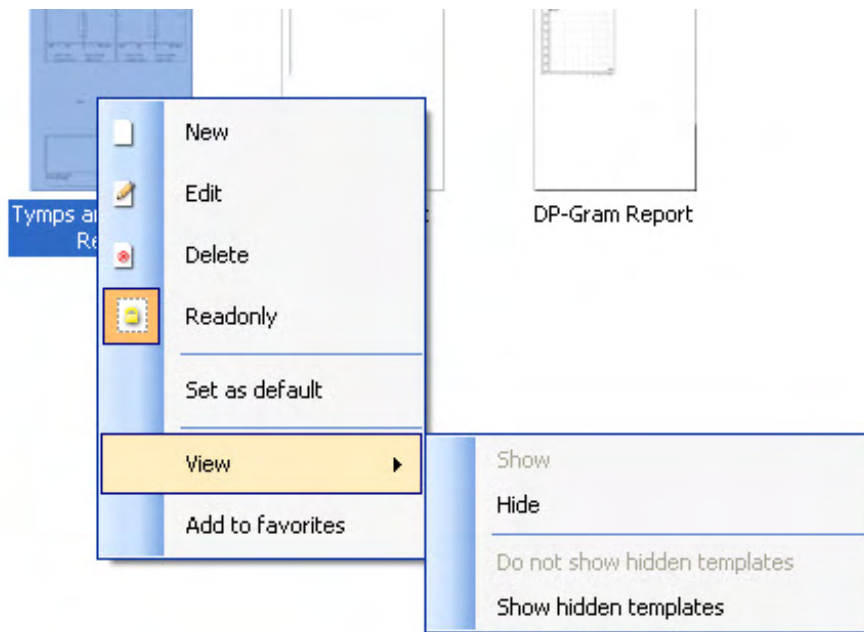

For more information related to the Print reports and Print Wizard, please refer Print Report Quick Guide on www.interacoustics.com.



4 Touch Keyboard (optional)

4.1 Product description

The Touch Keyboard is an optional accessory to the PC based audiometers Equinox Evo and Affinity Compact and cannot be used on its own. It is controlled by the software module AC440, referred to as 'Suite' henceforward.

The connection between the Touch Keyboard and Suite on the PC is used for sending control commands to the connected audiometer. These control commands are the same as if the audiometer was controlled by the Suite only, i.e. without the use of the Touch Keyboard.

The Touch Keyboard consists of a touch screen with a Graphical User Interface (GUI) and a wheel on the left and right side that contain 2 push buttons.

The Touch Keyboard is placed on a table and controlled by an operator. It is possible to use the Touch Keyboard wired but also to disconnect from the PC for wireless operation.

The patient is placed at a distance of 1.5 metres or more from the Touch Keyboard.

4.2 Standard parts

- Touch Keyboard
- Power Supply UES60LCP-200300SPC
- Power cable, USB-C
- USB-C to USB-A adapter
- Power splitter cable, 2 m

4.3 Operating instructions

Power consumption during normal use is up to 18W with full screen brightness and empty battery.

To minimize environmental impact and enhance battery life,

- choose settings that use less battery: set your device to go to sleep sooner and reduce screen brightness.
- turn off the device after use.

4.3.1 How to charge the Touch Keyboard

To charge the Touch Keyboard, connect it to the PC using the USB cable.

For optimal charging, connect the Touch Keyboard to the Power supply with the USB cable.

4.3.2 Getting ready for use

Make sure the Touch Keyboard is charged before use.

The Touch Keyboard charges when it is connected to a PC or to the Power Supply (for optimal charging) with the USB cable.

1. Make sure the Touch Keyboard is connected to the PC using the USB cable.
2. Turn on the Touch Keyboard: Push and hold the top buttons on both wheels simultaneously for 2 seconds.
3. If wireless connection is needed:
 - a. Enable wireless connection on the Touch Keyboard in the menu Device Setup.
 - b. Enable Bluetooth on the computer.
4. On the PC: Start the Suite software.
5. The Suite will automatically connect to the Touch Keyboard and update it if necessary.

During wireless use, the Touch Keyboard should remain within the vicinity of the PC.



4.3.3 General functionality

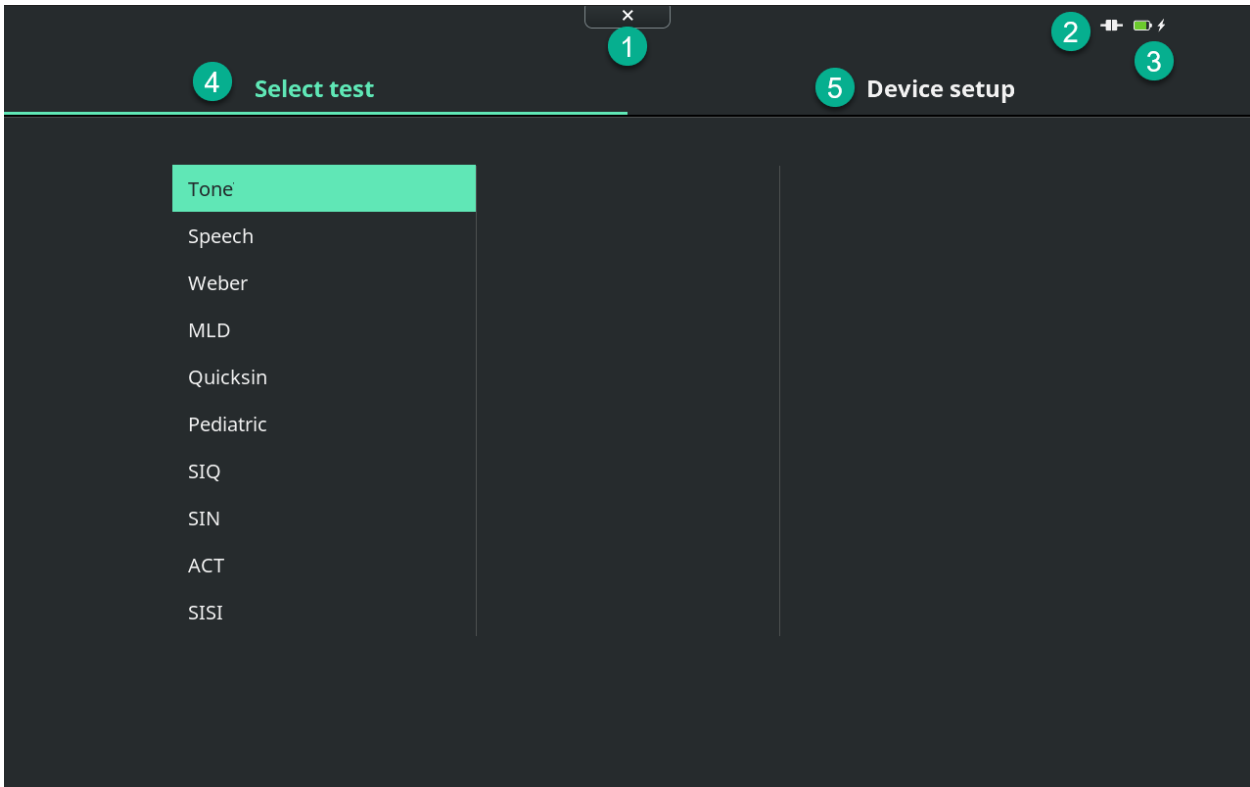

Number	Description
1	Press the menu bar in the uppermost-middle part of the screen to open general settings.
2	An icon in the upper-right corner indicates the connection status.
3	A battery indicator in the upper-right corner shows battery and charging status.
4	The <i>Select test</i> tab shows the tests that are defined in the Suite for the Touch Keyboard. Select the desired test and use the x button to leave this menu.
5	The <i>Device setup</i> tab gives access to <ul style="list-style-type: none">• Brightness of the screen• Wireless connection (on/off)• Sleep timer• Through 'About this touch keyboard' information on serial number, version and disclaimer



4.3.4 Messages

On the user interface, the following messages can appear:



All ongoing tests are interrupted, until Talk forward is deactivated again by pushing the top button on the left wheel.

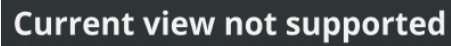

The Touch Keyboard does not support the current view of the Suite.

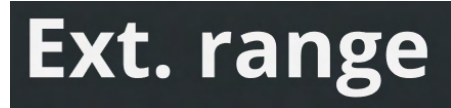

It is possible to present higher intensity levels to the patient.

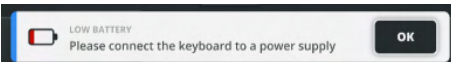

Low battery notice.



The Suite is not connected to an audiometer and is running in simulation mode.

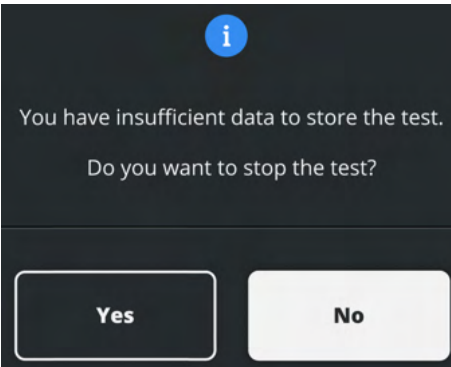

Insufficient data have been collected

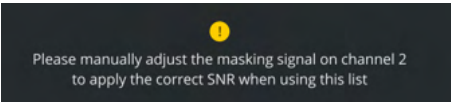

User is prompted to adjust masking signal for correct SNR values

4.3.5 Tone audiometry

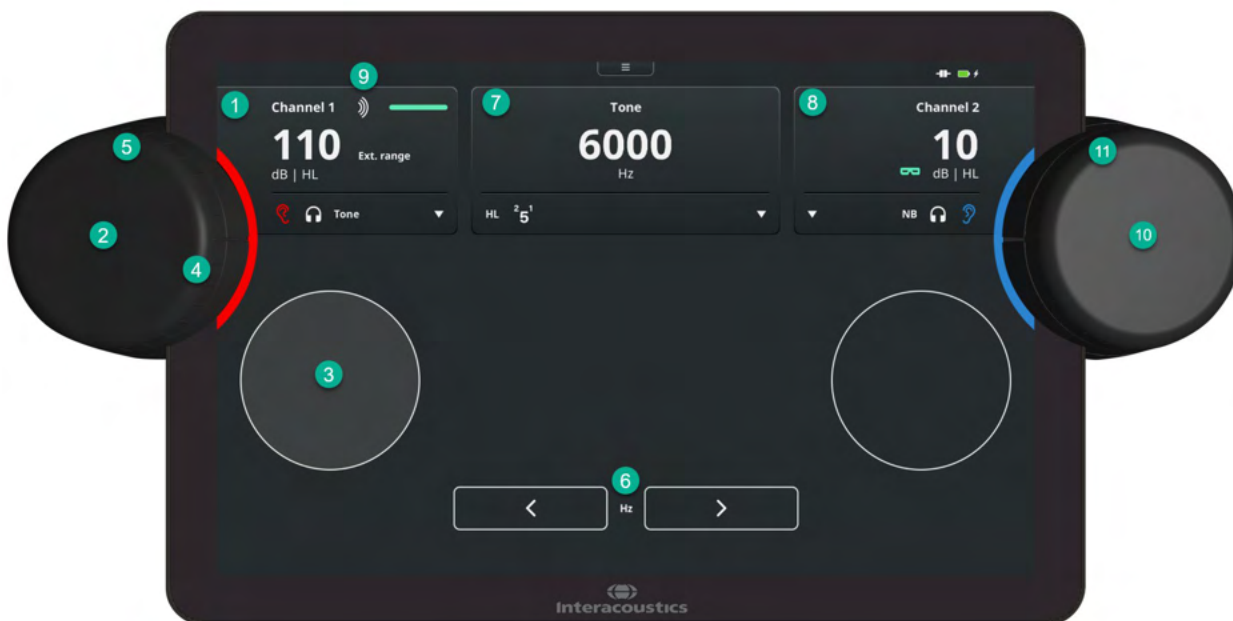

Number	Description
1	Upper-left corner: See and access channel 1 settings. Current settings are shown for <ul style="list-style-type: none"> intensity level earside transducer output <p>A horizontal green bar is shown when the patient presses the patient response.</p>
2	Touch the <i>arrow down sign</i> to change ear side, transducer and output type for channel 1.
3	Turn the left wheel to change intensity level for channel 1.
4	Touch the <i>left stimulus switch</i> to present a stimulus.
5	Push the lower button on the left wheel to store a threshold. Use a long press to store as 'no response'.
6	Push the top button on the left wheel to activate and deactivate the talk forward function. Turn the left wheel to adjust the volume for the patient when Talk Forward is activated.
7	Push and hold the top buttons on both wheels simultaneously for 3 seconds to turn off the Touch Keyboard.
8	Change the frequency in the bottom middle of the screen by touching the <i>left or right arrow sign</i> next to <i>Hz</i>
9	Upper-middle part of the screen: See and access overall settings. Current settings are shown for <ul style="list-style-type: none"> test selected frequency testtype dB stepsize <p>Touch the <i>arrow down sign</i> to change settings such as test type, dB stepsize or activation of aided measurement.</p>
10	Upper-right corner: See and access channel 2 settings. Current settings are shown for <ul style="list-style-type: none"> intensity level

Number	Description
	<ul style="list-style-type: none"> • earside • transducer and • output type • activated masking, if relevant <p>Touch the <i>arrow down sign</i> to change settings for earside, transducer and output type for channel 2.</p>
9	An icon is lighting up whenever a stimulus is being presented through the patient transducer.
10	Turn the right wheel to adjust the intensity level for channel 2. Turn completely down to turn channel 2 off and deactivate masking.
11	To turn off the Touch Keyboard, push and hold the top buttons on both wheels simultaneously for 3 seconds.

4.3.6 Speech audiometry

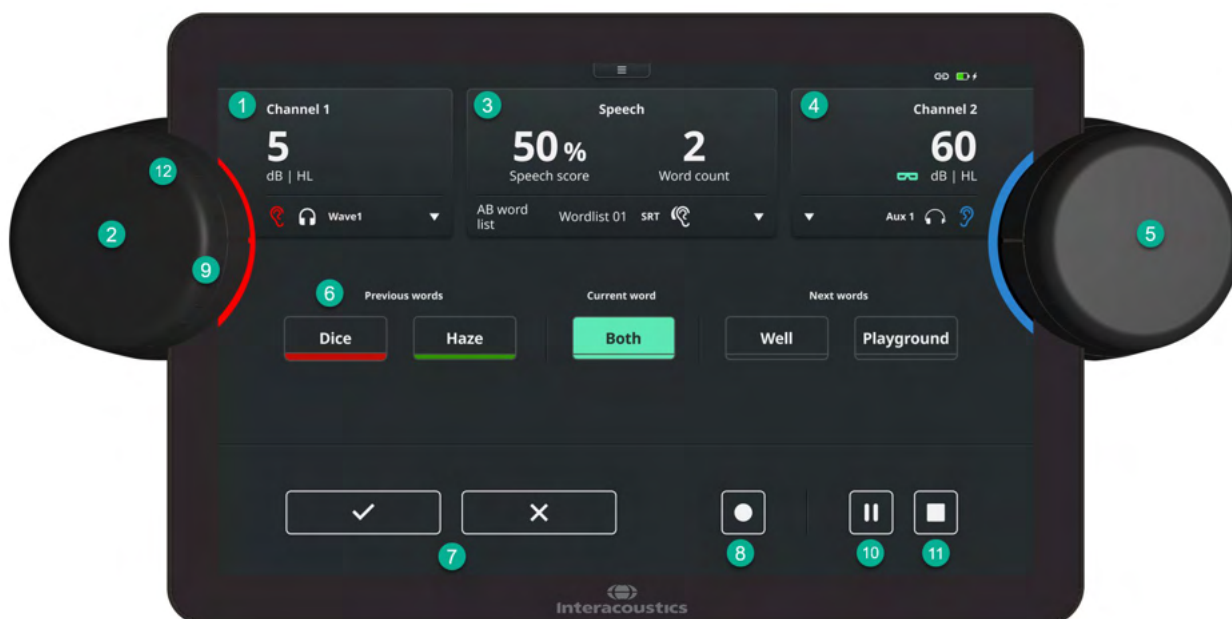

- | Number | Description |
|--------|---|
| 1 | Upper-left corner: See and access channel 1 settings. Current settings are shown for <ul style="list-style-type: none"> • intensity level • ear side • transducer • output |
| 2 | Touch the <i>arrow down sign</i> to change ear side, transducer and output type for channel 1. |
| 3 | Turn the left wheel to change intensity level for channel 1. |
| 3 | Upper-middle part of the screen: See and access overall settings. Current settings are shown for <ul style="list-style-type: none"> • results, e.g. speech score and word count • speech material • test type • activation of aided measurement |
| 4 | Touch the <i>arrow down sign</i> to change settings such as speech material, test type, or (de)activation of aided measurement. |
| 4 | Upper-right corner: See and access channel 2 settings. Current settings are shown for <ul style="list-style-type: none"> • intensity level • ear side • transducer • output type • activation of masking, if relevant |
| 5 | Touch the <i>arrow down sign</i> to change settings for ear side, transducer and output type for channel 2. |
| 5 | Turn the right wheel to adjust the intensity level for channel 2. |
| 6 | Turn completely down to turn channel 2 off and deactivate masking. |
| 6 | Middle part of the screen: Current speech material is shown. Green and red underlining indicates correct and incorrect repetition respectively. Green box indicates that the word is selected for presentation. |
| 7 | Word scoring: use v and x button for correct and incorrect repetition respectively. |

Number	Description
	Phoneme scoring: V and X will be replaced by the numbers 0-4. Use these to indicate the number of correctly repeated phonemes.
8	Store the measurement results with the touch button with the dot.
9	Measurement results can also be stored by pushing the lower button on the left wheel.
10	Start and pause the measurement with the pause/play button.
11	Stop the measurement with the touch button with the square.
12	Push the top button on the left wheel to activate and deactivate the talk forward function. Turn the left wheel to adjust the volume for the patient when Talk Forward is activated.
	Push and hold the top buttons on both wheels simultaneously for 3 seconds to turn off the Touch Keyboard.

4.3.7 Troubleshooting

The Touch Keyboard is unresponsive

Reboot the Touch Keyboard by



1. holding the 2 top buttons on both wheels for 10 seconds until the screen turns dark
2. wait some seconds
3. and then hold the 2 top buttons once more for 3 seconds. The screen will turn on again.

The Touch Keyboard is now reset.

4.3.8 Battery replacement

To replace the battery, follow below steps.

CAUTION: There is a risk of damaging the terminals for battery if the battery is removed from the top side of the battery. Remove the battery from the bottom side.

	<p>Remove the two screws on the bottom part of the keyboard. Use a torx T8 screwdriver.</p>
	<p>Flip the cover up and slide it out of the slot.</p>
	<p>From the bottom side of the battery: Use a plectrum or a similar tool to lift the battery out.</p> <p>Caution: Risk of damaging the terminals for the battery if removed from the top side of the battery.</p> <p>The battery can now be replaced.</p>

4.4 Touch Keyboard - Technical specifications

Dimensions (LxWxH)	16.4 x 33.0 x 5.1 cm / 6.5 x 13.0 x 2.0 inches
Weight	1.1 kg / 5.5 lbs.
Power supply	Use only specified power supply unit UES60 type Input: 100-240VAC 50/60Hz, 1.3 A Output: 20.0 VDC, 3 A
Battery type	RRC1130 Lithium-Polymer (Li-Po) 3.8V - 3814mAh - 14.47Wh
Battery cycle life	Up to 80% of initial capacity after 800 cycles
Charging current	900mA @ USB-C PD 20V
Working current	300mA @ USB-C PD 20V
Work time	1 hour
Connections	USB 2.0 via USB-C, or Wireless
Wireless characteristics	
Transmitting distance	10+ meters ⁶
Transmission power	0dBm
Transmission frequency	2400-2483,5 MHz
Magnetic emission	
Operation environment	Atmospheric pressure: 98 kPa – 104 kPa Temperature: 15 °C – 35 °C Re. Humidity: 30 – 90 % Non-condensing
Transport and storage	Transport temperature: -20 °C – 50 °C Storage temperature: 0 °C – 50 °C Re. Humidity: 10 – 95 % Non-condensing

⁶ Measured in free space with no obstructions in between.

4.5 Electromagnetic compatibility (EMC) Touch Keyboard

This equipment is suitable in hospital and clinical environments except for near-active HF surgical equipment and RF-shielded rooms of systems for magnetic resonance imaging, where the intensity of electromagnetic disturbance is high.

ESSENTIAL PERFORMANCE for this instrument is defined by the manufacturer as:

This instrument does not have an ESSENTIAL PERFORMANCE

Absence or loss of ESSENTIAL PERFORMANCE cannot lead to any unacceptable immediate risk

Final diagnosis shall always be based on clinical knowledge

Use of this instrument adjacent to or stacked with other equipment should be avoided because it could result in improper operation. If such use is necessary, this instrument and the other equipment should be observed to verify that they are operating normally.

Portable RF communications equipment (including peripherals such as antenna cables and external antennas) should be used no closer than 30 cm (12 inches) to any part of this equipment, including cables specified by the manufacturer. Otherwise, degradation of the performance of this equipment could result in improper operation.

This instrument is in compliance with IEC60601-1-2:2014+AMD1:2020, emission class B group 1

This instrument operates RF receivers in the frequency band: 2400-2483,5 MHz

This instrument operates RF transmitters in the frequency band: 2400-2483,5 MHz , modulation type: GFSK, $\pi/4$ -DQPSK, 8-DPSK with power: 1 mW/0 dBm

NOTICE: There are no deviations from the collateral standard and allowances uses

NOTICE: All necessary instruction for maintaining compliance with regard to EMC can be found in the general maintenance section in this instruction. No further steps required.

To ensure compliance with the EMC requirements as specified in IEC 60601-1-2, it is essential to use only the following accessories:

Item	Manufacturer	Model
Power supply	Dongguan Shilong Fuhua Electronic Co. Ltd.	UES60LCP-200300SPC

Conformance to the EMC requirements as specified in IEC 60601-1-2 is ensured if the cable types and cable lengths are as specified below:

Description	Length	Screened (Yes/No)
USB cables (PC)	1.9 meter	Yes

Guidance and manufacturer's declaration - electromagnetic emissions		
The Touch Keyboard is intended for use in the electromagnetic environment specified below. The customer or the user of the Touch Keyboard should assure that it is used in such an environment.		
Emissions Test	Compliance	Electromagnetic environment - guidance
RF emissions CISPR 11	Group 1	The Touch Keyboard uses RF energy only for its internal function. Therefore, its RF emissions are very low and are not likely to cause any interference in nearby electronic equipment.
RF emissions CISPR 11	Class B	The Touch Keyboard is suitable for use in all commercial, industrial, business, and residential environments.
Harmonic emissions IEC 61000-3-2	Complies Class A Category	
Voltage fluctuations / flicker emissions IEC 61000-3-3	Complies	

Recommended separation distances between portable and mobile RF communications equipment and the Touch Keyboard.			
The Touch Keyboard is intended for use in an electromagnetic environment in which radiated RF disturbances are controlled. The customer or the user of the Touch Keyboard can help prevent electromagnetic interferences by maintaining a minimum distance between portable and mobile RF communications equipment (transmitters) and the Touch Keyboard as recommended below, according to the maximum output power of the communications equipment.			
Rated Maximum output power of transmitter [W]	Separation distance according to frequency of transmitter [m]		
	150 kHz to 80 MHz $d = 1.17\sqrt{P}$	80 MHz to 800 MHz $d = 1.17\sqrt{P}$	800 MHz to 2.7 GHz $d = 2.23\sqrt{P}$
0.01	0.12	0.12	0.23
0.1	0.37	0.37	0.74
1	1.17	1.17	2.33
10	3.70	3.70	7.37
100	11.70	11.70	23.30
For transmitters rated at a maximum output power not listed above, the recommended separation distance d in meters (m) can be estimated using the equation applicable to the frequency of the transmitter, where P is the maximum output power rating of the transmitter in watts (W) according to the transmitter manufacturer.			
Note 1 At 80 MHz and 800 MHz, the higher frequency range applies.			
Note 2 These guidelines may not apply to all situations. Electromagnetic propagation is affected by absorption and reflection from structures, objects and people.			

Guidance and Manufacturer's Declaration - Electromagnetic Immunity

The Touch Keyboard is intended for use in the electromagnetic environment specified below. The customer or the user of the Touch Keyboard should assure that it is used in such an environment.

Immunity Test	IEC 60601 Test level	Compliance	Electromagnetic environment - guidance
Electrostatic Discharge (ESD) IEC 61000-4-2	+8 kV contact +15 kV air	+8 kV contact +15 kV air	Floors should be wood, concrete or ceramic tile. If floors are covered with synthetic material, the relative humidity should be greater than 30%.
Immunity to proximity fields from RF wireless communications equipment IEC 61000-4-3	Spot freq. 385-5.785 MHz Levels and modulation defined in table 9	As defined in table 9 of AMD 1: 2020	RF wireless communications equipment should not be used close to any parts of the Touch Keyboard.
Electrical fast transient/burst IEC61000-4-4	+2 kV for power supply lines +1 kV for input/output lines	+2 kV for power supply lines +1 kV for input/output lines	Mains power quality should be that of a typical commercial or residential environment.
Surge IEC 61000-4-5	+1 kV Line to line +2 kV Line to earth	+1 kV Line to line +2 kV Line to earth	Mains power quality should be that of a typical commercial or residential environment.
Voltage dips, short interruptions and voltage variations on power supply lines IEC 61000-4-11	0% <i>UT</i> (100% dip in <i>UT</i>) for 0.5 cycle, @ 0, 45, 90, 135, 180, 225, 270 and 315° 0% <i>UT</i> (100% dip in <i>UT</i>) for 1 cycle 40% <i>UT</i> (60% dip in <i>UT</i>) for 5 cycles 70% <i>UT</i> (30% dip in <i>UT</i>) for 25 cycles 0% <i>UT</i> (100% dip in <i>UT</i>) for 250 cycles	0% <i>UT</i> (100% dip in <i>UT</i>) for 0.5 cycle, @ 0, 45, 90, 135, 180, 225, 270 and 315° 0% <i>UT</i> (100% dip in <i>UT</i>) for 1 cycle 40% <i>UT</i> (60% dip in <i>UT</i>) for 5 cycles 70% <i>UT</i> (30% dip in <i>UT</i>) for 25 cycles 0% <i>UT</i> (100% dip in <i>UT</i>) for 250 cycles	Mains power quality should be that of a typical commercial or residential environment. If the user of the Touch Keyboard requires continued operation during power mains interruptions, it is recommended that the Touch Keyboard be powered from an uninterruptable power supply or its battery.
Power frequency (50/60 Hz) IEC 61000-4-8	30 A/m	30 A/m	Power frequency magnetic fields should be at levels characteristic of a typical location in a typical commercial or residential environment.
Radiated fields in close proximity — Immunity test IEC 61000-4-39	9 kHz to 13.56 MHz. Frequency, level and modulation defined in AMD 1: 2020, table 11	As defined in table 11 of AMD 1: 2020	If the Touch Keyboard contains magnetically sensitive components or circuits, the proximity magnetic fields should be no higher than the test levels specified in Table 11

Note: *UT* is the A.C. mains voltage prior to application of the test level.

Guidance and manufacturer's declaration — electromagnetic immunity			
The Touch Keyboard is intended for use in the electromagnetic environment specified below. The customer or the user of the Touch Keyboard should assure that it is used in such an environment,			
Immunity test	IEC / EN 60601 test level	Compliance level	Electromagnetic environment – guidance
Conducted RF IEC / EN 61000-4-6	3 Vrms 150kHz to 80 MHz	3 Vrms	Portable and mobile RF communications equipment should be used no closer to any parts of the Touch Keyboard, including cables, than the recommended separation distance calculated from the equation applicable to the frequency of the transmitter. Recommended separation distance: $d = \frac{3,5}{V_{rms}} \sqrt{P}$
Radiated RF IEC / EN 61000-4-3	6 Vrms In ISM bands (and amateur radio bands for Home Healthcare environment.)	6 Vrms	
	3 V/m 80 MHz to 2,7 GHz	3 V/m	
	10 V/m 80 MHz to 2,7 GHz Only for Home Healthcare environment	10 V/m (If Home Healthcare)	$d = \frac{3,5}{v/m} \sqrt{P} \quad 80 \text{ MHz to } 800 \text{ MHz}$ $d = \frac{7}{v/m} \sqrt{P} \quad 800 \text{ MHz to } 2,7 \text{ GHz}$ Where P is the maximum output power rating of the transmitter in watts (W) according to the transmitter manufacturer and d is the recommended separation distance in meters (m). Field strengths from fixed RF transmitters, as determined by an electromagnetic site survey, ^a should be less than the compliance level in each frequency range. ^b Interference may occur in the vicinity of equipment marked with the following symbol:



Note 1 At 80 MHz and 800 MHz, the higher frequency range applies
Note 2 These guidelines may not apply in all situations. Electromagnetic propagation is affected by absorption and reflection from structures, objects and people.

a) Field strengths from fixed transmitters, such as base stations for radio (cellular/cordless) telephones and land mobile radios, amateur radio, AM and FM radio broadcast and TV broadcast cannot be predicted theoretically with accuracy. To assess the electromagnetic environment due to fixed RF transmitters, an electromagnetic site survey should be considered. If the measured field strength in the location in which the Touch Keyboard is used exceeds the applicable RF compliance level above, the Touch Keyboard should be observed to verify normal operation, If abnormal performance is observed, additional measures may be necessary, such as reorienting or relocating the Touch Keyboard.

b) Over the frequency range 150 kHz to 80 MHz, field strengths should be less than 3 V/m.

4.6 Licenses

Third-party software information on permissive licenses	<p>Name: FreeRTOS-Kernel v10.5.1 Authors: Open Source – Amazon Web Services License: MIT open source license Source Code: GitHub - FreeRTOS/FreeRTOS-Kernel at V10.5.1</p> <p>Name: LVGL v8.3.0 Authors: LVGL — Light and Versatile Embedded Graphics Library License: MIT open source license Source Code: GitHub - lvgl/lvgl at release/v8.3</p> <p>Name: LittleFS v2.5.0 Authors: Copyright (c) 2022, The littlefs authors. Copyright (c) 2017, Arm Limited. All rights reserved. License: BSD-3-Clause license Source Code: GitHub - littlefs-project/littlefs: A little fail-safe filesystem designed for microcontrollers</p> <p>Name: MCUXpresso SDK v2.11.1 Authors: Automotive, IoT & Industrial Solutions NXP Semiconductors License: BSD-3-Clause license Source Code: GitHub - nxp-mcuxpresso/mcux-sdk: MCUXpresso SDK</p> <p>Name: ESP-IDF v4.3.4 Authors: Wireless SoCs, Software, Cloud and AIoT Solutions Espressif Systems License: Apache-2.0 license Source Code: GitHub - espressif/esp-idf: Espressif IoT Development Framework. Official development framework for Espressif SoCs. License: Apache-2.0 license Source Code: GitHub - espressif/esp-idf: Espressif IoT Development Framework. Official development framework for Espressif SoCs.</p>
--	---

5 Maintenance

5.1 General maintenance procedures

The performance and safety of the instrument will be kept if the following instructions for care and maintenance are followed:

- The instrument must be serviced annually, to ensure that the acoustical, electrical, and mechanical properties are correct. This should be made by an authorised technician to guaranty proper service and repair.
 - Authorised technician is not required for battery change on the Touch keyboard. Replacing the battery is done by following the instruction in this document.
- To ensure that the reliability of the instrument is kept, it is recommended that the operator perform a test on a person with known data, on regular intervals (for instance, once a week). This person could be the operator him/herself.
- After each examination of a patient the equipment and accessories that are in contact with the patient should be visually inspected. General precautions must be observed to avoid cross-contamination between patients. If ear cushions or ear tips are contaminated, it is strongly recommended to remove them from the transducer before the transducers are cleaned. Usage of disinfectants is recommended. The use of organic solvents and aromatic oils must be avoided.

NOTICE

- Great care should be exercised when handling earphones and other transducers, as mechanical shock may cause a change in calibration.

5.2 How to clean Interacoustics products

The surface of the device or accessories can be cleaned using a soft cloth moistened with a mild solution of water and dish washing detergent or similar. The use of organic solvents and aromatic oils must be avoided. Always disconnect power sources during the cleaning process and be careful that no liquid enters the device or the accessories.



- Before cleaning always switch off and disconnect from power source.
- Use a soft cloth lightly dampened with cleaning solution to clean all exposed surfaces.
- Do not allow liquid to meet the metal parts inside the earphones / headphones.
- Do not autoclave, sterilize, or immerse the instrument or accessory in any fluid.
- Do not use hard or pointed objects to clean any part of the instrument or accessory.
- Do not let parts that have been in contact with fluids dry before cleaning.
- Foam ear tips are single use products.

Recommended cleaning solutions:

- Warm water with mild, nonabrasive cleaning solution (soap).
- 80% Ethanol
- 70% isopropyl alcohol

Procedure:

- Clean the instrument by wiping outer case with a lint free cloth lightly dampened in cleaning solution
- Clean cushions and patient hand switch and other parts with a lint free cloth lightly dampened in cleaning solution
- Make sure not to get moisture in the speaker of the earphones and similar parts
- Allow the cleaning solution to dry before turning on the instrument.

5.3 Concerning repair

Interacoustics is only considered to be responsible for the validity of the CE marking, effects on safety, reliability, and performance of the equipment if:

1. assembly operations, extensions, readjustments, modifications, or repairs are carried out by authorised persons
2. a 1-year service interval is maintained
3. the electrical installation of the relevant room complies with the appropriate requirements, and
4. the equipment is used by authorised personnel in accordance with the documentation supplied by Interacoustics.

The customer shall reach out to the local distributor to determine the service/repair possibilities including onsite service/repair. It is important that the customer (through local distributor) fills out the **RETURN REPORT** every time when the component/product is sent for service/repair to Interacoustics.

5.4 Warranty

Interacoustics warrants that:

- The Equinox Evo is free from defects in material and workmanship under normal use and service for a period of 12 months from the date of delivery by Interacoustics to the first purchaser
- Accessories are free from defects in material and workmanship under normal use and service for a period of ninety (90) days from the date of delivery by Interacoustics to the first purchaser

If any product requires service during the applicable warranty period, the purchaser should communicate directly with the local Interacoustics service centre to determine the appropriate repair facility. Repair or replacement will be carried out at Interacoustics' expense, subject to the terms of this warranty. The product requiring service should be returned promptly, properly packed, and postage prepaid. Loss or damage in return shipment to Interacoustics shall be at purchaser's risk.

In no event shall Interacoustics be liable for any incidental, indirect or consequential damages in connection with the purchase or use of any Interacoustics product.

This shall apply solely to the original purchaser. This warranty shall not apply to any subsequent owner or holder of the product. Furthermore, this warranty shall not apply to, and Interacoustics shall not be responsible for, any loss arising in connection with the purchase or use of any Interacoustics product that has been:

- repaired by anyone other than an authorized Interacoustics service representative
- altered in any way so as, in Interacoustics judgement, to affect its stability or reliability
- subject to misuse or negligence or accident, or which has had the serial or lot number altered, effaced, or removed; or
- improperly maintained or used in any manner other than in accordance with the instructions furnished by Interacoustics

This warranty is in lieu of all other warranties, express or implied, and of all other obligations or liabilities of Interacoustics, and Interacoustics does not give or grant, directly or indirectly, the authority to any representative or other person to assume on behalf of Interacoustics any other liability in connection with the sale of Interacoustics products.

Interacoustics disclaims all other warranties, expressed or implied, including any warranty of merchantability or for function of fitness for a particular purpose or application.

5.5 Replacement of consumables

5.5.1 Foam tips

Foam tips used for the audiometric insert phone transducers are easily replaced. They are connected to the insert phone tube by the tube nipple as shown on the below image. They are replaced by pressing them on the tube nipple or pulling them off.

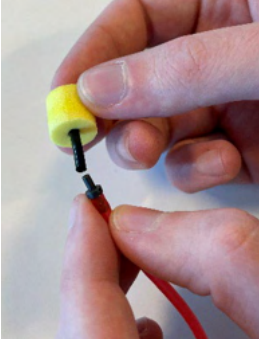

Foam tips are for single use only.

For ordering of new foam tips, please refer to the local Interacoustics distributor.

6 General technical specifications

6.1 Equinox Evo - Technical Specifications

Medical CE mark	The CE mark indicates that Interacoustics A/S meets the requirements of the Medical Device Regulation (EU) 2017/745 Annex I. Approval of the quality system is made by TÜV – identification no. 0123.	
Safety standards	IEC 60601-1 2005+AMD1:2012+AMD2:2020 (Edition 3.2) ANSI/AAMI ES60601-1:2005 & A1:2012 & A2:2021 CSA-C22.2 No.60601-1:14 + A2:22 (R2022) Class I, Applied parts type B, Continuous operation	
EMC standard	IEC 60601-1-2:2014+AMD1:2020 Class B, group 1	
Calibration	Technical information is in the specifications for the software modules. Calibration information and instructions are located in the Service manual.	
PC requirements (Minimum requirements)	2 GHz Intel i3 processor 5 th generation or equal 4GB Ram 2.5 GB available disk space 1280x720 resolution (1280x1024 or higher recommended) Hardware accelerated DirectX/Direct3D graphics card. One or more USB ports, version 2.0 or higher.	
Operating Systems	Windows® 10 (64 bit) Windows® 11 (64 bit)	
Compatible software	Noah 4, OtoAccess® and XML compatible.	
Input specifications	Talk back	226mVrms at max. input gain for 0dB VU-reading Input impedance: 68kΩ 7mVrms max input with 10 dB headroom over 0dB Vu-reading
	Mic. – Talk Forward	226mVrms at max. input gain for 0dB VU-reading Input impedance: 68kΩ 7mVrms max input with 10 dB headroom over 0dB Vu-reading
	Assistant monitor Mic.	226μVrms at max input gain for 0 dB Vu-reading, Input impedance 68kΩ. 7mVrms max input with 10 dB headroom over 0dB Vu-reading
	Patient respond	Switches 3.3V to the logic input. (The switch current is 1.5mA)
	AUX 1-2	16mVrms at max. input gain for 0dB VU-reading Input impedance: 68kΩ 500mVrms max input with 10 dB headroom over 0dB Vu-reading
	Talk back Ambient mic.	Max input level before clipping 70mVrms. Calibration by 94 dB SPL 250Hz or 1kHz. Input impedance: 68kΩ
Output specifications	Phone	Up to 7.0 Vrms by 10 Ω load 70Hz-20kHz ±3dB
	Insert	Up to 7.0 Vrms by 10 Ω load 70Hz-20kHz ±3dB
	HF	Up to 7Vrms by 10 Ω load 70Hz-20kHz ±3dB
	Bone	Up to 7.0 Vrms by 10 Ω load 70Hz-20kHz ±3dB
	FF1 / FF2 power	Up to 14.0Vrms by 8 Ω load 70Hz-20kHz ±3dB Minimum speaker impedance: 4Ω

	FF1-2 Line	Up to 7.0 Vrms by 1 kΩ load 70Hz-20kHz ±3dB
	FF3-4 Line	Up to 7.0 Vrms by 1 kΩ load 70Hz-20kHz ±3dB
	Monitor	Up to 1.5Vrms by 8Ω load 125-20kHz ±3dB
	Assistant monitor	Up to 1.5Vrms by 8Ω load 125-20kHz ±3dB
	VRA	Contact switch current < 500mA
Data connections	USB-PC	USB B socket for connection to PC (compatible with USB 2.0 and later)
Dimensions (LxWxH)	26.4 x 26.4 x 6 cm / 10.4 x 10.4 x 2.4 inches	
Weight	1.8 kg / 4.0 lbs.	
Power supply	Type: UES65-240250SPA3 Input: 100-240VAC 50/60Hz, 2.0 A Output: 24.0 VDC, 2.5 A Average consumption: 24.1W	
Operation environment	Atmospheric pressure: 98 kPa – 104 kPa Temperature: 15 °C – 35 °C Re. Humidity: 30 – 90 % Non-condensing	
Transport and storage	Transport temperature: -20 °C – 50 °C Storage temperature: 0 °C – 50 °C Re. Humidity: 10 – 95 % Non-condensing	

6.2 Tone reference equivalent threshold values for transducers

PURE TONE RETSPL								
TRANSDUCER	DD45	DD65 v2	DD450	IP30	B71	B71	B81	B81
COUPLER	6ccm	ARTIFICIAL EAR	ARTIFICIAL EAR	2ccm	MASTOID	FOREHEAD	MASTOID	FOREHEAD
	RETSPL	RETSPL	RETSPL	RETSPL	RETFL	RETFL	RETFL	RETFL
Tone 125 Hz	47.5	30.5	30.5	26				
Tone 160 Hz	40.5	25.5	26	22				
Tone 200 Hz	33.5	21.5	22	18				
Tone 250 Hz	27	17	18	14	67	79	67	79
Tone 315 Hz	22.5	14	15.5	12	64	76.5	64	76.5
Tone 400 Hz	17.5	10.5	13.5	9	61	74.5	61	74.5
Tone 500 Hz	13	8	11	5.5	58	72	58	72
Tone 630 Hz	9	6.5	8	4	52.5	66	52.5	66
Tone 750 Hz	6.5	5.5	6	2	48.5	61.5	48.5	61.5
Tone 800 Hz	6.5	5	6	1.5	47	59	47	59
Tone 1000 Hz	6	4.5	5.5	0	42.5	51	42.5	51
Tone 1250 Hz	7	3.5	6	2	39	49	39	49
Tone 1500 Hz	8	2.5	5.5	2	36.5	47.5	36.5	47.5
Tone 1600 Hz	8	2.5	5.5	2	35.5	46.5	35.5	46.5
Tone 2000 Hz	8	2.5	4.5	3	31	42.5	31	42.5
Tone 2500 Hz	8	2	3	5	29.5	41.5	29.5	41.5
Tone 3000 Hz	8	2	2.5	3.5	30	42	30	42
Tone 3150 Hz	8	3	4	4	31	42.5	31	42.5
Tone 4000 Hz	9	9.5	9.5	5.5	35.5	43.5	35.5	43.5
Tone 5000 Hz	13	15.5	14	5	40	51	40	51
Tone 6000 Hz	20.5	21	17	2	40	51	40	51
Tone 6300 Hz	19	21	17.5	2	40	50	40	50
Tone 8000 Hz	12	21	17.5	0	40	50	40	50
Tone 9000 Hz			19					
Tone 10000 Hz			22					
Tone 11200 Hz			23					
Tone 12500 Hz			27.5					
Tone 14000 Hz			35					
Tone 16000 Hz			56					
Tone 18000 Hz			83					
Tone 20000 Hz			105					

DD45 6ccm uses IEC 60318-3 or NBS 9A coupler and RETSPL comes from ISO 389-1:2017, ANSI S3.6-2018 (R2023) and ISO389-1:2017. Force 4.5N ±0.5N

DD65V2 Artificial ear uses IEC 60318-1 coupler with type 1 adaptor and RETSPL comes from PTB 1.61-4091606 2018 & AAU 2018, Force 11.5N ±0.5N

DD450 Artificial ear uses IEC 60318-1 coupler with type 1 adaptor and RETSPL comes from ANSI S3.6-2018 (R2023) and ISO 389-8:2004. Force 9N ±0.5N

IP30 2ccm use ANSI S3.7-1995 or IEC 60318-5 coupler (HA-2 with 5mm rigid Tube) and RETSPL comes from ANSI S3.6-2018 (R2023) and ISO 389-2:1994.

B71 / B-81 use ANSI S3.13 or IEC 60318-6:2007 mechanical coupler and RETFL come from ANSI S3.6:2018 (R2023) and ISO 389-3:2016 Force 5.4N ±0.5N

PURE TONE MAX. HL

TRANSDUCER	DD45	DD65 v2	DD450	IP30	B71	B71	B81	B81
IMPEDANCE	10 Ω	10 Ω	40 Ω	10 Ω	10 Ω	10 Ω	12.5 Ω	12.5 Ω
COUPLER	6ccm	ARTIFICIAL EAR	ARTIFICIAL EAR	2ccm	MASTOID	FOREHEAD	MASTOID	FOREHEAD
Signal	Max. HL	Max. HL	Max. HL	Max. HL	Max. HL	Max. HL	Max. HL	Max. HL
Tone 125 Hz	90	85	100	90				
Tone 160 Hz	95	90	105	95				
Tone 200 Hz	100	95	105	100				
Tone 250 Hz	110	100	110	105	45	30	50	35
Tone 315 Hz	115	105	115	105	50	35	60	45
Tone 400 Hz	120	110	115	110	65	50	70	55
Tone 500 Hz	120	110	115	110	65	50	70	55
Tone 630 Hz	120	110	120	115	70	55	75	60
Tone 750 Hz	120	115	120	115	70	55	75	60
Tone 800 Hz	120	115	120	115	70	55	75	60
Tone 1000 Hz	120	115	120	120	70	60	85	75
Tone 1250 Hz	120	115	110	120	70	60	90	80
Tone 1500 Hz	120	115	115	120	70	55	90	80
Tone 1600 Hz	120	115	115	120	70	55	90	75
Tone 2000 Hz	120	115	115	120	75	60	90	75
Tone 2500 Hz	120	115	115	120	80	65	85	70
Tone 3000 Hz	120	115	115	120	80	65	85	70
Tone 3150 Hz	120	115	115	120	80	65	85	70
Tone 4000 Hz	120	110	115	115	80	70	85	70
Tone 5000 Hz	120	105	105	105	60	45	70	55
Tone 6000 Hz	115	100	105	100	50	35	60	50
Tone 6300 Hz	115	100	105	100	50	40	55	45
Tone 8000 Hz	110	95	105	95	50	40	50	40
Tone 9000 Hz			100					
Tone 10000 Hz			100					
Tone 11200 Hz			95					
Tone 12500 Hz			90					
Tone 14000 Hz			80					
Tone 16000 Hz			60					
Tone 18000 Hz			30					
Tone 20000 Hz			15					

NB NOISE EFFECTIVE MASKING LEVEL								
TRANSDUCER	DD45	DD65 v2	DD450	IP30	B71	B71	B81	B81
IMPEDANCE	10 Ω	10 Ω	40 Ω	10 Ω	10 Ω	10 Ω	12.5 Ω	12.5 Ω
COUPLER	6ccm	ARTIFICIAL EAR	ARTIFICIAL EAR	2ccm	MASTOID	FOREHEAD	MASTOID	FOREHEAD
	EM	EM	EM	EM	EM	EM	EM	EM
NB 125 Hz	51.5	34.5	34.5	30				
NB 160 Hz	44.5	29.5	30	26				
NB 200 Hz	37.5	25.5	26	22				
NB 250 Hz	31	21	22	18	71	83	71	83
NB 315 Hz	26.5	18	19.5	16	68	80.5	68	80.5
NB 400 Hz	21.5	14.5	17.5	13	65	78.5	65	78.5
NB 500 Hz	17	12	15	9.5	62	76	62	76
NB 630 Hz	14	11.5	13	9	57.5	71	57.5	71
NB 750 Hz	11.5	10.5	11	7	53.5	66.5	53.5	66.5
NB 800 Hz	11.5	10	11	6.5	52	64	52	64
NB 1000 Hz	12	10.5	11.5	6	48.5	57	48.5	57
NB 1250 Hz	13	9.5	12	8	45	55	45	55
NB 1500 Hz	14	8.5	11.5	8	42.5	53.5	42.5	53.5
NB 1600 Hz	14	8.5	11.5	8	41.5	52.5	41.5	52.5
NB 2000 Hz	14	8.5	10.5	9	37	48.5	37	48.5
NB 2500 Hz	14	8	9	11	35.5	47.5	35.5	47.5
NB 3000 Hz	14	8	8.5	9.5	36	48	36	48
NB 3150 Hz	14	9	10	10	37	48.5	37	48.5
NB 4000 Hz	14	14.5	14.5	10.5	40.5	48.5	40.5	48.5
NB 5000 Hz	18	20.5	19	10	45	56	45	56
NB 6000 Hz	25.5	26	22	7	45	56	45	56
NB 6300 Hz	24	26	22.5	7	45	55	45	55
NB 8000 Hz	17	26	22.5	5	45	55	45	55
NB 9000 Hz			24					
NB 10000 Hz			27					
NB 11200 Hz			28					
NB 12500 Hz			32.5					
NB 14000 Hz			40					
NB 16000 Hz			61					
NB 18000 Hz			88					
NB 20000 Hz			110					
White noise	0	0	0	0	42.5	51	42.5	51
TEN noise	25			16				

Effective masking value is RETSPL / RETFL add 1/3 octave correction for Narrow-band noise from ANSI S3.6-2018 (R2023) or ISO 389-4:1994.

NB NOISE MAX. HL

TRANSDUCER	DD45	DD65 v2	DD450	IP30	B71	B71	B81	B81
IMPEDANCE	10 Ω	10 Ω	40 Ω	10 Ω	10 Ω	10 Ω	12.5 Ω	12.5 Ω
COUPLER	6ccm	ARTIFICIAL EAR	ARTIFICIAL EAR	2ccm	MASTOID	FOREHEAD	MASTOID	FOREHEAD
	Max. HL	Max. HL	Max HL	Max. HL	Max. HL	Max HL	Max. HL	Max HL
NB 125 Hz	75	75	75	90				
NB 160 Hz	80	80	80	95				
NB 200 Hz	90	85	80	100				
NB 250 Hz	95	90	85	105	35	20	40	25
NB 315 Hz	100	95	90	105	40	25	50	35
NB 400 Hz	105	100	95	105	55	40	60	45
NB 500 Hz	110	100	95	110	55	40	60	45
NB 630 Hz	110	100	95	110	60	45	65	50
NB 750 Hz	110	105	100	110	60	45	65	50
NB 800 Hz	110	105	100	110	60	45	65	50
NB 1000 Hz	110	105	100	110	60	50	70	60
NB 1250 Hz	110	105	95	110	60	50	75	60
NB 1500 Hz	110	105	100	110	60	45	75	60
NB 1600 Hz	110	105	100	110	60	45	75	60
NB 2000 Hz	110	105	100	110	65	50	70	55
NB 2500 Hz	110	105	100	110	65	50	65	50
NB 3000 Hz	110	105	100	110	65	50	65	50
NB 3150 Hz	110	100	100	110	65	50	65	50
NB 4000 Hz	110	100	100	110	65	55	60	50
NB 5000 Hz	110	95	95	105	50	35	55	45
NB 6000 Hz	105	90	90	100	45	30	50	40
NB 6300 Hz	105	90	90	100	40	30	45	35
NB 8000 Hz	100	85	90	95	40	30	40	30
NB 9000 Hz			85					
NB 10000 Hz			85					
NB 11200 Hz			80					
NB 12500 Hz			75					
NB 14000 Hz			70					
NB 16000 Hz			50					
NB 18000 Hz			20					
NB 20000 Hz			0					
White noise	120	120	115	110	70	70	70	60
TEN noise	110			100				

Speech reference equivalent threshold value for transducer

ANSI SPEECH RETSPL								
TRANSDUCER	DD45	DD65 v2	DD450	IP30	B71	B71	B81	B81
Impedance	10 Ω	10 Ω	40 Ω	10 Ω	10 Ω	10 Ω	12.5 Ω	12.5 Ω
COUPLER	6ccm	ARTIFICIAL EAR	ARTIFICIAL EAR	2ccm	MASTOID	FOREHEAD	MASTOID	FOREHEAD
	RETSPL	RETSPL	RETSPL	RETSPL	RETFL	RETFL	RETFL	RETFL
Speech	18.5	17	19					
Speech Equ.FF.	18.5	16.5	18.5					
Speech Non-linear	6	4.5	5.5	12.5	55	63.5	55	63.5
Speech noise	18.5	17	19					
Speech noise Equ.FF.	18.5	16.5	18.5					
Speech noise Non-linear	6	4.5	5.5	12.5	55	63.5	55	63.5
White noise in speech	21	19.5	21.5	15	57.5	66	57.5	66

DD45 (G_F-G_C) PTB-DTU report 2009-2010.

DD65V2 (GF-GC) PTB-AAU report 2018.

DD450 (G_F-G_C) ANSI S3.6-2018 (R2023) and ISO 389-8:2004.

ANSI Speech level 12.5 dB + 1 kHz RETSPL ANSI S3.6-2018 (R2023) (acoustical linear weighting).

ANSI Speech Equivalent free field level 12.5 dB + 1 kHz RETSPL - (G_F-G_C) from ANSI S3.6-2018 (R2023) (acoustical equivalent sensitivity weighting).

ANSI Speech Not linear level 1 kHz RETSPL ANSI S3.6-2018 (R2023) (DD45, DD65V2, DD450) and IP30, B71 and B81 12.5 dB + 1 kHz RETSPL ANSI S3.6-2018 (R2023) (no weighting).

ANSI SPEECH MAX. HL								
TRANSDUCER	DD45	DD65 v2	DD450	IP30	B71	B71	B81	B81
Impedance	10 Ω	10 Ω	40 Ω	10 Ω	10 Ω	10 Ω	12.5 Ω	12.5 Ω
COUPLER	6ccm	ARTIFICIAL EAR	ARTIFICIAL EAR	2ccm	MASTOID	FOREHEAD	MASTOID	FOREHEAD
	Max. HL	Max. HL	Max. HL	Max. HL	Max. HL	Max. HL	Max. HL	Max. HL
Speech	110	100	90					
Speech Equ.FF.	100	95	85					
Speech Non-linear	120	110	110	110	60	40	60	50
Speech noise	100	95	85					
Speech noise Equ.FF.	100	90	80					
Speech noise Non-linear	115	105	105	110	50	40	50	40
White noise in speech	95	95	90	95	55	45	60	50

IEC SPEECH RETSPL								
TRANSDUCER	DD45	DD65 v2	DD450	IP30	B71	B71	B81	B81
Impedance	10 Ω	10 Ω	40 Ω	10 Ω	10 Ω	10 Ω	12.5 Ω	12.5 Ω
COUPLER	6ccm	ARTIFICIAL EAR	ARTIFICIAL EAR	2ccm	MASTOID	FOREHEAD	MASTOID	FOREHEAD
	RETSP L	RETSPL	RETSPL	RETSP L	RETFL	RETFL	RETFL	RETFL
Speech	20	20	20					
Speech Equ.FF.	3.5	1.5	3.5					
Speech Non-linear	6	4.5	5.5	20	55	63.5	55	63.5
Speech noise	20	20	20					
Speech noise Equ.FF.	3.5	1.5	3.5					
Speech noise Non-linear	6	4.5	5.5	20	55	63.5	55	63.5
White noise in speech	22.5	22.5	22.5	22.5	57.5	66	57.5	66

DD45 (G_F-G_C) PTB-DTU report 2009-2010.

DD65V2 (GF-GC) PTB-AAU report 2018.

DD450 (G_F-G_C) ANSI S3.6-2018 (R2023) and ISO 389-8:2004.

IEC Speech level IEC 60645-1:2017 (acoustical linear weighting).

IEC Speech Equivalent free field level (G_F-G_C) from IEC 60645-1:2017 (acoustical equivalent sensitivity weighting).

IEC Speech Not linear level 1 kHz RETSPL (DD45, DD65V2, DD450) and IP30, B7 and B81 IEC 60645-1:2017 (no weighting).

IEC SPEECH MAX. HL								
TRANSDUCER	DD45	DD65 v2	DD450	IP30	B71	B71	B81	B81
IMPEDANCE	10 Ω	10 Ω	40 Ω	10 Ω	10 Ω	10 Ω	12.5 Ω	12.5 Ω
COUPLER	6ccm	ARTIFICIAL EAR	ARTIFICIAL EAR	2ccm	MASTOID	FOREHEAD	MASTOID	FOREHEAD
	Max. HL	Max. HL	Max. HL	Max. HL	Max. HL	Max. HL	Max. HL	Max. HL
Speech	110	95	90					
Speech Equ.FF.	115	110	100					
Speech Non-linear	120	110	110	100	60	40	60	50
Speech noise	100	90	85					
Speech noise Equ.FF.	115	10	95					
Speech noise Non-linear	115	105	105	90	50	40	50	40
White noise in speech	95	95	90	85	55	45	60	50

SWEDEN SPEECH RETSPL								
TRANSDUCER	DD45	DD65 v2	DD450	IP30	B71	B71	B81	B81
Impedance	10 Ω	10 Ω	40 Ω	10 Ω	10 Ω	10 Ω	12.5 Ω	12.5 Ω
COUPLER	6ccm	ARTIFICIAL EAR	ARTIFICIAL EAR	2ccm	MASTOID	FOREHEAD	MASTOID	FOREHEAD
	RETSPL	RETSPL	RETSPL	RETSPL	RETFL	RETFL	RETFL	RETFL
Speech	22	20	20					
Speech Equ.FF.	3.5	1.5	3.5					
Speech Non-linear	22	4.5	5.5	21	55	63.5	55	63.5
Speech noise	27	20	20					
Speech noise Equ.FF.	3.5	1.5	3.5					
Speech noise Non-linear	27	4.5	5.5	26	55	63.5	55	63.5
White noise in speech	22.5	22.5	22.5	22.5	57.5	66	57.5	66

DD45 (G_F-G_C) PTB-DTU report 2009-2010.

DD65V2 (GF-GC) PTB-AAU report 2018.

DD450 (G_F-G_C) ANSI S3.6-2018 (R2023) and ISO 389-8:2004.

Sweden Speech level STAF 1996 and IEC 60645-1:2017 (acoustical linear weighting).

Sweden Speech Equivalent free field level (G_F-G_C) from IEC 60645-1:2017 (acoustical equivalent sensitivity weighting).

Sweden Speech Not linear level 1 kHz RETSPL (DD45, DD65V2, DD450) and IP30, B71 and B81 STAF 1996 and IEC 60645-1:2017 (no weighting).

SWEDEN SPEECH MAX. HL								
TRANSDUCER	DD45	DD65 v2	DD450	IP30	B71	B71	B81	B81
IMPEDANCE	10 Ω	10 Ω	40 Ω	10 Ω	10 Ω	10 Ω	12.5 Ω	12.5 Ω
COUPLER	6ccm	ARTIFICIAL EAR	ARTIFICIAL EAR	2ccm	MASTOID	FOREHEAD	MASTOID	FOREHEAD
	Max. HL	Max. HL	Max. HL	Max. HL	Max. HL	Max. HL	Max. HL	Max. HL
Speech	108	95	90					
Speech Equ.FF.	115	110	100					
Speech Non-linear	104	110	110	99	60	40	60	50
Speech noise	93	90	85					
Speech noise Equ.FF.	115	100	95					
Speech noise Non-linear	94	105	105	84	50	40	50	40
White noise in speech	95	95	90	85	55	45	60	50

NORWAY SPEECH RETSPL								
TRANSDUCER	DD45	DD65 v2	DD450	IP30	B71	B71	B81	B81
IMPEDANCE	10 Ω	10 Ω	40 Ω	10 Ω	10 Ω	10 Ω	12.5 Ω	12.5 Ω
COUPLER	6ccm	ARTIFICIAL EAR	ARTIFICIAL EAR	2ccm	MASTOID	FOREHEAD	MASTOID	FOREHEAD
	RETSPL	RETSPL	RETSPL	RETSPL	RETFL	RETFL	RETFL	RETFL
Speech	40	40	40					
Speech Equ.FF.	3.5	1.5	3.5					
Speech Non-linear	6	4.5	5.5	40	75	83.5	75	83.5
Speech noise	40	40	40					
Speech noise Equ.FF.	3.5	1.5	3.5					
Speech noise Non-linear	6	4.5	5.5	40	75	83.5	75	83.5
White noise in speech	22.5	22.5	22.5	22.5	57.5	66	57.5	66

DD45 (G_F-G_C) PTB-DTU report 2009-2010.

DD65V2 (GF-GC) PTB-AAU report 2018.s

DD450 (G_F-G_C) ANSI S3.6-2018 (R2023) and ISO 389-8:2004.

Norway Speech level IEC 60645-1:2017 +20dB (acoustical linear weighting).

Norway Speech Equivalent free field level (G_F-G_C) from IEC 60645-1:2017 (acoustical equivalent sensitivity weighting).

Norway Speech Not linear level 1 kHz RETSPL (DD45, DD65V2, DD450) and IP30, B71 and B81 IEC 60645-1 2017 +20dB (no weighting).

NORWAY SPEECH MAX. HL								
TRANSDUCER	DD45	DD65 v2	DD450	IP30	B71	B71	B81	B81
IMPEDANCE	10 Ω	10 Ω	40 Ω	10 Ω	10 Ω	10 Ω	12.5 Ω	12.5 Ω
COUPLER	6ccm	ARTIFICIAL EAR	ARTIFICIAL EAR	2ccm	MASTOID	FOREHEAD	MASTOID	FOREHEAD
	Max. HL	Max. HL	Max HL	Max. HL	Max. HL	Max HL	Max. HL	Max HL
Speech	90	75	70					
Speech Equ.FF.	115	110	100					
Speech Non-linear	120	110	110	80	40	20	40	30
Speech noise	80	70	65					
Speech noise Equ.FF.	115	100	95					
Speech noise Non-linear	115	105	105	70	30	20	30	20
White noise in speech	95	95	90	85	55	45	60	50

JAPAN SPEECH RETSPL								
TRANSDUCER	DD45	DD65 v2	DD450	IP30	B71	B71	B81	B81
IMPEDANCE	10 Ω	10 Ω	40 Ω	10 Ω	10 Ω	10 Ω	12.5 Ω	12.5 Ω
COUPLER	6ccm	ARTIFICIAL EAR	ARTIFICIAL EAR	2ccm	MASTOID	FOREHEAD	MASTOID	FOREHEAD
	RETSP L	RETSPL	RETSPL	RETSPL	RETFL	RETFL	RETFL	RETFL
Speech	14	14	14					
Speech Equ.FF.	3.5	1.5	3.5					
Speech Non-linear	6	4.5	5.5	14	49	57.5	49	57.5
Speech noise	14	14	14					
Speech noise Equ.FF.	3.5	1.5	3.5					
Speech noise Non-linear	6	4.5	5.5	14	49	57.5	49	57.5
White noise in speech	22.5	22.5	22.5	22.5	57.5	66	57.5	66

DD45 (G_F-G_C) PTB-DTU report 2009-2010.

DD65 v2 (GF-GC) PTB-AAU report 2018.

DD450 (G_F-G_C) ANSI S3.6 2018 (R2023) and ISO 389-8:2004.

Japan Speech level JIS T1201-2:2000 (acoustical linear weighting).

Japan Speech Equivalent free field level (G_F-G_C) from IEC60645-1 2017 (acoustical equivalent sensitivity weighting).

Japan Speech Not linear level 1 kHz RETSPL (DD45, DD65V2, DD450) and IP30, B71 and B81 IEC 60645-1:2017 (no weighting).

JAPAN SPEECH MAX. HL								
TRANSDUCER	DD45	DD65 v2	DD450	IP30	B71	B71	B81	B81
IMPEDANCE	10 Ω	10 Ω	40 Ω	10 Ω	10 Ω	10 Ω	12.5 Ω	12.5 Ω
COUPLER	6ccm	ARTIFICIAL EAR	ARTIFICIAL EAR	2ccm	MASTOID	FOREHEAD	MASTOID	FOREHEAD
	Max. HL	Max. HL	Max HL	Max. HL	Max. HL	Max HL	Max. HL	Max HL
Speech	116	101	96					
Speech Equ.FF.	115	110	100					
Speech Non-linear	120	110	110	106	66	46	66	56
Speech noise	106	96	91					
Speech noise Equ.FF.	115	100	95					
Speech noise Non-linear	115	105	105	96	56	46	56	46
White noise in speech	95	95	90	85	55	45	60	50

SPL SPEECH RETSPL

TRANSDUCER	DD45	DD65 v2	DD450	IP30	B71	B71	B81	B81
IMPEDANCE	10 Ω	10 Ω	40 Ω	10 Ω	10 Ω	10 Ω	12.5 Ω	12.5 Ω
COUPLER	6ccm	ARTIFICIAL EAR	ARTIFICIAL EAR	2ccm	MASTOID	FOREHEAD	MASTOID	FOREHEAD
	RETSPL	RETSPL	RETSPL	RETSPL	RETFL	RETFL	RETFL	RETFL
Speech	0	0	0	0	0	0	0	0
Speech Equ.FF.	0	0	0					
Speech Non-linear	0	0	0					
Speech noise	0	0	0	0	0	0	0	0
Speech noise Equ.FF.	0	0	0					
Speech noise Non-linear	0	0	0					

DD45 (G_F-G_C) PTB-DTU report 2009-2010.

DD65V2 (GF-GC) PTB-AAU report 2018.

DD450 (G_F-G_C) ANSI S3.6-2018 (R2023) and ISO 389-8:2004.

SPL SPEECH MAX. HL

TRANSDUCER	DD45	DD65 v2	DD450	IP30	B71	B71	B81	B81
IMPEDANCE	10 Ω	10 Ω	40 Ω	10 Ω	10 Ω	10 Ω	12.5 Ω	12.5 Ω
COUPLER	6ccm	ARTIFICIAL EAR	ARTIFICIAL EAR	2ccm	MASTOID	FOREHEAD	MASTOID	FOREHEAD
	Max. HL	Max. HL	Max HL	Max. HL	Max. HL	Max HL	Max. HL	Max HL
Speech	120	115	105	120	110	105	110	105
Speech Equ.FF.	115	110	100					
Speech Non-linear	120	110	115					
Speech noise	115	110	100	110	105	100	105	100
Speech noise Equ.FF.	115	105	95					
Speech noise Non-linear	120	105	110					
White noise in speech	115	115	110	105	110	108.5	115	113.5

FREE FIELD

ANSI S3.6-2018 (R2023)					FREE FIELD MAX. SPL					
ISO 389-7:2005					FREE FIELD MAX. HL IS FOUND BY SUBTRACTING THE SELECTED RETSPL VALUE					
FREQUENCY	BINAURAL			BINAURAL TO MONAURAL CORRECTION	FREE FIELD POWER		FREE FIELD LINE		FREE FIELD INTERNAL	
	0°	45°	90°		TONE	NB	TONE	NB	TONE	NB
	RETSPL	RETSPL	RETSPL	RETSPL	MAX. SPL	MAX. SPL	MAX. SPL	MAX. SPL	MAX. SPL	MAX. SPL
Hz	dB	dB	dB	dB	dB	dB	dB	dB	dB	dB
125	22	21.5	21	2	97	82	102	97	82	72
160	18	17	16.5	2	93	83	98	93	78	68
200	14.5	13.5	13	2	94.5	84.5	104.5	99.5	84.5	74.5
250	11.5	10.5	9.5	2	96.5	86.5	106.5	101.5	86.5	76.5
315	8.5	7	6	2	93.5	83.5	103.5	98.5	83.5	73.5
400	6	3.5	2.5	2	96	86	106	101	91	81
500	4.5	1.5	0	2	94.5	84.5	104.5	99.5	89.5	79.5
630	3	-0.5	-2	2	93	83	103	98	88	78
750	2.5	-1	-2.5	2	92.5	82.5	102.5	97.5	87.5	77.5
800	2	-1.5	-3	2	92	87	107	102	87	77
1000	2.5	-1.5	-3	2	92.5	82.5	102.5	97.5	87.5	77.5
1250	3.5	-0.5	-2.5	2	93.5	83.5	103.5	98.5	88.5	78.5
1500	2.5	-1	-2.5	2	92.5	82.5	102.5	97.5	87.5	77.5
1600	1.5	-2	-3	2	96.5	86.5	106.5	101.5	91.5	81.5
2000	-1.5	-4.5	-3.5	2	93.5	83.5	103.5	98.5	88.5	78.5
2500	-4	-7.5	-6	2	91	81	101	96	86	76
3000	-6	-11	-8.5	2	94	84	104	94	89	79
3150	-6	-11	-8	2	94	84	104	94	89	79
4000	-5.5	-9.5	-5	2	94.5	84.5	104.5	99.5	89.5	79.5
5000	-1.5	-7.5	-5.5	2	93.5	83.5	108.5	98.5	88.5	78.5
6000	4.5	-3	-5	2	94.5	84.5	104.5	99.5	89.5	79.5
6300	6	-1.5	-4	2	96	86	106	96	91	81
8000	12.5	7	4	2	87.5	72.5	92.5	87.5	87.5	77.5
White Noise	0	-4	-5.5	2		90		100		85

ANSI FREE FIELD

ANSI S3.6-2018 (R2023)					FREE FIELD MAX. SPL		
					FREE FIELD MAX. HL IS FOUND BY SUBTRACTING THE SELECTED RETSPL VALUE		
	BINAURAL			BINAURAL TO MONAURAL CORRECTION	FREE FIELD POWER	FREE FIELD LINE	FREE FIELD INTERNAL
	0°	45°	90°		0° - 45° - 90°	0° - 45° - 90°	0° - 45° - 90°
	RETSPL	RETSPL	RETSPL	RETSPL	MAX. SPL	MAX. SPL	MAX. SPL
Speech	15	11	9.5	2	90	100	80
Speech Noise	15	11	9.5	2	85	100	75
Speech WN	17.5	13.5	12	2	87.5	97.5	82.5

IEC FREE FIELD

ISO 389-7:2005					FREE FIELD MAX. SPL		
					FREE FIELD MAX. HL IS FOUND BY SUBTRACTING THE SELECTED RETSPL VALUE		
	BINAURAL			BINAURAL TO MONAURAL CORRECTION	FREE FIELD POWER	FREE FIELD LINE	FREE FIELD INTERNAL
	0°	CORRECTION	90°		0° - 45° - 90°	0° - 45° - 90°	0° - 45° - 90°
	RETSPL	RETSPL	RETSPL	RETSPL	MAX. SPL	MAX. SPL	MAX. SPL
Speech	0	-4	-5.5	2	90	100	80
Speech Noise	0	-4	-5.5	2	85	100	75
Speech WN	2.5	-1.5	-3	2	87.5	97.5	82.5

SWEDEN FREE FIELD

ISO 389-7:2005					FREE FIELD MAX. SPL		
					FREE FIELD MAX. HL IS FOUND BY SUBTRACTING THE SELECTED RETSPL VALUE		
BINAURAL				BINAURAL TO MONAURAL	FREE FIELD POWER	FREE FIELD LINE	FREE FIELD INTERNAL
0°	45°	90°		CORRECTION	0° - 45° - 90°	0° - 45° - 90°	0° - 45° - 90°
	RETSPL	RETSPL	RETSPL	RETSPL	MAX. SPL	MAX. SPL	MAX. SPL
Speech	0	-4	-5.5	2	90	100	80
Speech Noise	0	-4	-5.5	2	85	100	75
Speech WN	2.5	-1.5	-3	2	87.5	97.5	82.5

NORWAY FREE FIELD

ISO 389-7:2005					FREE FIELD MAX. SPL		
					FREE FIELD MAX. HL IS FOUND BY SUBTRACTING THE SELECTED RETSPL VALUE		
BINAURAL				BINAURAL TO MONAURAL	FREE FIELD POWER	FREE FIELD LINE	FREE FIELD INTERNAL
0°	45°	90°		CORRECTION	0° - 45° - 90°	0° - 45° - 90°	0° - 45° - 90°
	RETSPL	RETSPL	RETSPL	RETSPL	MAX. SPL	MAX. SPL	MAX. SPL
Speech	0	-4	-5.5	2	90	100	80
Speech Noise	0	-4	-5.5	2	85	100	75
Speech WN	2.5	-1.5	-3	2	87.5	97.5	82.5

JAPAN FREE FIELD

ISO 389-7:2005					FREE FIELD MAX. SPL		
					FREE FIELD MAX. HL IS FOUND BY SUBTRACTING THE SELECTED RETSPL VALUE		
BINAURAL				BINAURAL TO MONAURAL	FREE FIELD POWER	FREE FIELD LINE	FREE FIELD INTERNAL
0°	45°	90°		CORRECTION	0° - 45° - 90°	0° - 45° - 90°	0° - 45° - 90°
	RETSPL	RETSPL	RETSPL	RETSPL	MAX. SPL	MAX. SPL	MAX. SPL
Speech	10	6	4.5	2	90	100	80
Speech Noise	10	6	4.5	2	85	100	75
Speech WN	2.5	-1.5	-3	2	87.5	97.5	82.5

SPL FREE FIELD

ISO 389-7:2005					FREE FIELD MAX. SPL		
					FREE FIELD MAX. HL IS FOUND BY SUBTRACTING THE SELECTED RETSPL VALUE		
BINAURAL				BINAURAL TO MONAURAL	FREE FIELD POWER	FREE FIELD LINE	FREE FIELD INTERNAL
0°	45°	90°		CORRECTION	0° - 45° - 90°	0° - 45° - 90°	0° - 45° - 90°
	RETSPL	RETSPL	RETSPL	RETSPL	MAX. SPL	MAX. SPL	MAX. SPL
Speech	0	0	0	0	90	100	80
Speech Noise	0	0	0	0	85	100	75
Speech WN	2.5	-1.5	-3	2	87.5	97.5	82.5

EQUIVALENT FREE FIELD



SPEECH AUDIOMETER			
	DD45	DD65V2	DD450
	PTB – DTU 2010	PTB-AAU 2018	ISO389-8:2004
COUPLER	IEC 60318-3	IEC 60318-1	IEC 60318-1
FREQUENCY	G _F -G _c	G _F -G _c	G _F -G _c
125	-21.5	-4.5	-5,0
160	-17.5	-3.5	-4,5
200	-14.5	-4.5	-4,5
250	-12.0	-4.5	-4,5
315	-9.5	-4.0	-5,0
400	-7.0	-2.0	-5,5
500	-7.0	-3.0	-2,5
630	-6.5	-2.0	-2,5
750			
800	-4.0	-2.0	-3,0
1000	-3.5	-1.5	-3,5
1250	-3.5	-1.5	-2,0
1500			
1600	-7.0	-3.0	-5,5
2000	-7.0	-2.5	-5,0
2500	-9.5	-2.5	-6,0
3000		-5.5	
3150	-12.0	-9.5	-7,0
4000	-8.0	-9.5	-13,0
5000	-8.5	-13.0	-14,5
6000			
6300	-9.0	-9.0	-11,0
8000	-1.5	-4.5	-8,5



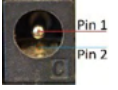
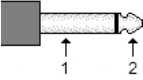
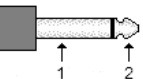
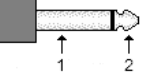
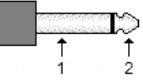
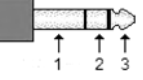

SOUND ATTENUATION VALUES FOR EARPHONES

FREQUENCY	ATTENUATION			
	DD45 with MX41/AR or PN 51 Cushion	IP30	DD65V2	DD450
[Hz]	[dB]*	[dB]*	[dB]*	[dB]*
125	3	33	8.3	15
160	4	34	8.7	15
200	5	35	11.7	16
250	5	36	15.5	16
315	5	37	19.5	18
400	6	37	23.4	20
500	7	38	26.1	23
630	9	37	28.5	25
750	-			
800	11	37	28.2	27
1000	15	37	32.4	29
1250	18	35	30.8	30
1500	-			
1600	21	34	33.7	31
2000	26	33	43.6	32
2500	28	35	47.5	37
3000	-			
3150	31	37	41.5	41
4000	32	40	43.8	46
5000	29	41	46.7	45
6000	-			
6300	26	42	45.7	45
8000	24	43	45.6	44

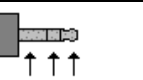
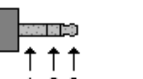
*ISO 8253-1:2010

6.3 Pin assignments

Socket	Connector	Pin 1	Pin 2	Pin 3	Pin 4
Mains +24Vdc	 DC connector	+24Vdc	0Vdc	N/A	N/A
AC1-Left	 6.3mm Mono	Ground	Signal	N/A	N/A
AC1-Right					
AC2-Left	 6.3mm Mono	Ground	Signal	N/A	N/A
AC2-Right					
AC3-Left	 6.3mm Mono	Ground	Signal	N/A	N/A
AC3-Right					
Bone	 6.3mm Mono	Ground	Signal	N/A	N/A
FF1	 6.3mm Mono	Signal -	Signal +	N/A	N/A
FF2	 6.3mm Mono	Signal -	Signal +	N/A	N/A
Patient response	 6.3mm Stereo	Ground	Ground		N/A
FF1-2 line out	 3.5mm Stereo	Ground	Signal FF1 line	Signal FF2 line	N/A
FF3-4 line out	 3.5mm Stereo	Ground	Signal FF3 line	Signal FF4 line	N/A
Monitor Headset	 3.5mm Stereo	Monitor ground	Monitor Right	Monitor Left	N/A

Socket	Connector	Pin 1	Pin 2	Pin 3	Pin 4
Talk Forward Mic	 3.5mm Stereo	Ground	DC bias	Signal	N/A
AUX	 3.5mm Stereo	Ground	AUX-2	AUX-1	N/A
Assistant Monitor	 3.5mm 4-pin	Mic. signal	Ground	Monitor Right	Monitor Left
Talk Back / Ambient		Ground	Mic. One wire	Mic. Bias	Mic. Signal
VRA		Common	VRA-3	VRA-2	VRA-1
USB connector	 USB device	+5 VDC	Data -	Data +	Ground

6.4 Electromagnetic compatibility (EMC) Equinox Evo

The Equinox Evo is suitable in hospital and clinical environments except for near-active HF surgical equipment and RF-shielded rooms of systems for magnetic resonance imaging, where the intensity of electromagnetic disturbance is high.

ESSENTIAL PERFORMANCE for this instrument is defined by the manufacturer as:

This instrument does not have an ESSENTIAL PERFORMANCE

Absence or loss of ESSENTIAL PERFORMANCE cannot lead to any unacceptable immediate risk

Final diagnosis shall always be based on clinical knowledge.

Use of this instrument adjacent to or stacked with other equipment should be avoided because it could result in improper operation. If such use is necessary, this instrument and the other equipment should be observed to verify that they are operating normally.

Portable RF communications equipment (including peripherals such as antenna cables and external antennas) should be used no closer than 30 cm (12 inches) to any part of this equipment, including cables specified by the manufacturer. Otherwise, degradation of the performance of this equipment could result in improper operation.

This instrument is in compliance with IEC60601-1-2:2014+AMD1:2020, emission class B group 1

NOTICE: There are no deviations from the collateral standard and allowances uses

NOTICE: All necessary instruction for maintaining compliance with regard to EMC can be found in the general maintenance section in this instruction. No further steps required.

To ensure compliance with the EMC requirements as specified in IEC 60601-1-2, it is essential to use only the following accessories:

Item	Manufacturer	Model
Power supply	Fuhua/UE Electronic	UES65-240250SPA3
USB cable	Sanibel	8011241

Conformance to the EMC requirements as specified in IEC 60601-1-2 is ensured if the cable types and cable lengths are as specified below:

Description	Length max [m]	Shielded (Yes/No)
Audiometric Headsets	2.0	Y
Audiometric Insert-Headsets	2.0	Y
Audiometric Headsets for High Frequency	2.0	Y
Bone conductors	2.0	N
Assistants Monitor Headsets	2.9	Y
Monitor Headsets w. microphone	2.9	Y
Patient response buttons	2.0	Y
Ambient Microphone	5.0	Y
Microphone for Talk Forward	2.0	Y
Microphone for Talk Back	2.0	Y
FF-Line cables for amplifier	1.0	Y
Loudspeakers (FF Power)	1.8	N
VRA cable	1.2	N

Guidance and manufacturer's declaration - electromagnetic emissions		
The EQUINOX EVO is intended for use in the electromagnetic environment specified below. The customer or the user of the EQUINOX EVO should assure that it is used in such an environment.		
Emissions Test	Compliance	Electromagnetic environment - guidance
RF emissions CISPR 11	Group 1	The EQUINOX EVO uses RF energy only for its internal function. Therefore, its RF emissions are very low and are not likely to cause any interference in nearby electronic equipment.
RF emissions CISPR 11	Class B	The EQUINOX EVO is suitable for use in all commercial, industrial, business, and residential environments.
Harmonic emissions IEC 61000-3-2	Complies Class A Category	
Voltage fluctuations / flicker emissions IEC 61000-3-3	Complies	

Recommended separation distances between portable and mobile RF communications equipment and the EQUINOX EVO .			
The EQUINOX EVO is intended for use in an electromagnetic environment in which radiated RF disturbances are controlled. The customer or the user of the EQUINOX EVO can help prevent electromagnetic interferences by maintaining a minimum distance between portable and mobile RF communications equipment (transmitters) and the EQUINOX EVO as recommended below, according to the maximum output power of the communications equipment.			
Rated Maximum output power of transmitter [W]	Separation distance according to frequency of transmitter [m]		
	150 kHz to 80 MHz $d = 1.17\sqrt{P}$	80 MHz to 800 MHz $d = 1.17\sqrt{P}$	800 MHz to 2.7 GHz $d = 2.23\sqrt{P}$
0.01	0.12	0.12	0.23
0.1	0.37	0.37	0.74
1	1.17	1.17	2.33
10	3.70	3.70	7.37
100	11.70	11.70	23.30
For transmitters rated at a maximum output power not listed above, the recommended separation distance d in meters (m) can be estimated using the equation applicable to the frequency of the transmitter, where P is the maximum output power rating of the transmitter in watts (W) according to the transmitter manufacturer.			
Note 1 At 80 MHz and 800 MHz, the higher frequency range applies.			
Note 2 These guidelines may not apply to all situations. Electromagnetic propagation is affected by absorption and reflection from structures, objects and people.			

Guidance and Manufacturer's Declaration - Electromagnetic Immunity			
The EQUINOX EVO is intended for use in the electromagnetic environment specified below. The customer or the user of the EQUINOX EVO should assure that it is used in such an environment.			
Immunity Test	IEC 60601 Test level	Compliance	Electromagnetic Environment-Guidance
Electrostatic Discharge (ESD) IEC 61000-4-2	+8 kV contact +15 kV air	+8 kV contact +15 kV air	Floors should be wood, concrete or ceramic tile. If floors are covered with synthetic material, the relative humidity should be greater than 30%.
Electrical fast transient/burst IEC61000-4-4	+2 kV for power supply lines +1 kV for input/output lines	+2 kV for power supply lines +1 kV for input/output lines	Mains power quality should be that of a typical commercial or residential environment.
Surge IEC 61000-4-5	+1 kV differential mode +2 kV common mode	+1 kV differential mode +2 kV common mode	Mains power quality should be that of a typical commercial or residential environment.
Voltage dips, short interruptions and voltage variations on power supply lines IEC 61000-4-11	< 5% UT (>95% dip in UT) for 0.5 cycle 40% UT (60% dip in UT) for 5 cycles 70% UT (30% dip in UT) for 25 cycles <5% UT (>95% dip in UT) for 5 sec	< 5% UT (>95% dip in UT) for 0.5 cycle 40% UT (60% dip in UT) for 5 cycles 70% UT (30% dip in UT) for 25 cycles <5% UT	Mains power quality should be that of a typical commercial or residential environment. If the user of the EQUINOX EVO requires continued operation during power mains interruptions, it is recommended that the EQUINOX EVO be powered from an uninterruptable power supply or its battery.
Power frequency (50/60 Hz) IEC 61000-4-8	30 A/m	30 A/m	Power frequency magnetic fields should be at levels characteristic of a typical location in a typical commercial or residential environment.
Note: UT is the A.C. mains voltage prior to application of the test level.			

Guidance and manufacturer's declaration — electromagnetic immunity			
The EQUINOX EVO is intended for use in the electromagnetic environment specified below. The customer or the user of the EQUINOX EVO should assure that it is used in such an environment,			
Immunity test	IEC / EN 60601 test level	Compliance level	Electromagnetic environment – guidance
<p>Conducted RF IEC / EN 61000-4-6</p> <p>Radiated RF IEC / EN 61000-4-3</p>	<p>3 Vrms 150kHz to 80 MHz</p> <p>6 Vrms in ISM bands 150kHz to 80 MHz 80 % AM at 1 kHz</p> <p>3 V/m 80 MHz to 2,7 GHz 80 % AM at 1 kHz</p>	<p>3 Vrms</p> <p>6 Vrms</p> <p>3 V/m</p>	<p>Portable and mobile RF communications equipment should be used no closer to any parts of the EQUINOX EVO, including cables, than the recommended separation distance calculated from the equation applicable to the frequency of the transmitter.</p> <p>Recommended separation distance</p> $d = 1,2\sqrt{P}$ $d = 1,2\sqrt{P} \quad 80 \text{ MHz to } 800 \text{ MHz}$ $d = 2,3\sqrt{P} \quad 800 \text{ MHz to } 2,7 \text{ GHz}$ <p>Where P is the maximum output power rating of the transmitter in watts (W) according to the transmitter manufacturer and d is the recommended separation distance in meters (m).</p> <p>Field strengths from fixed RF transmitters, as determined by an electromagnetic site survey, (a) should be less than the compliance level in each frequency range (b)</p> <p>Interference may occur in the vicinity of equipment marked with the following symbol:</p> 
NOTE1 At 80 MHz and 800 MHz, the higher frequency range applies			
NOTE 2 These guidelines may not apply in all situations. Electromagnetic propagation is affected by absorption and reflection from structures, objects and people.			
<p>^(a) Field strengths from fixed transmitters, such as base stations for radio (cellular/cordless) telephones and land mobile radios, amateur radio, AM and FM radio broadcast and TV broadcast cannot be predicted theoretically with accuracy. To assess the electromagnetic environment due to fixed RF transmitters, an electromagnetic site survey should be considered. If the measured field strength in the location in which the EQUINOX EVO is used exceeds the applicable RF compliance level above, the EQUINOX EVO should be observed to verify normal operation, If abnormal performance is observed, additional measures may be necessary, such as reorienting or relocating the EQUINOX EVO.</p> <p>^(b) Over the frequency range 150 kHz to 80 MHz, field strengths should be less than 3 V/m.</p>			

Return Report – Form 001



Opr. dato: 2014-03-07 af: EC Rev. dato: 30.01.2023 af: MHNG Rev. nr.: 5

Company: _____

Address: _____

Phone: _____

e-mail: _____

Address
DGS Diagnostics Sp. z o.o.
Rosówek 43
72-001 Kolbaskowo
Poland

Mail:
rma-diagnostics@dgs-diagnostics.com

Contact person: _____ Date: _____

Following item is reported to be:

- returned to INTERACOUSTICS for: repair, exchange, other: _____
- defective as described below with request of assistance
- repaired locally as described below
- showing general problems as described below

Item: _____ **Type:** _____ **Quantity:** _____

Serial No.: _____ Supplied by: _____

Included parts: _____

Important! - Accessories used together with the item must be included if returned (e.g. external power supply, headsets, transducers and couplers).

Description of problem or the performed local repair:

Returned according to agreement with: Interacoustics, Other : _____

Date : _____ Person : _____

Please provide e-mail address to whom Interacoustics may confirm reception of the returned goods: _____

The above mentioned item is reported to be dangerous to patient or user ¹

In order to ensure instant and effective treatment of returned goods, it is important that this form is filled in and placed together with the item.
Please note that the goods must be carefully packed, preferably in original packing, in order to avoid damage during transport. (Packing material may be ordered from Interacoustics)

¹ EC Medical Device Directive rules require immediate report to be sent, if the device by malfunction deterioration of performance or characteristics and/or by inadequacy in labelling or instructions for use, has caused or could have caused death or serious deterioration of health to patient or user.